

EQUO Series
Power Sensor Station
ZN-KMX21

User's Manual

По вопросам продаж и поддержки обращайтесь:

Архангельск (8182)63-90-72
Астана +7(7172)727-132
Астрахань (8512)99-46-04
Барнаул (3852)73-04-60
Белгород (4722)40-23-64
Брянск (4832)59-03-52
Владивосток (423)249-28-31
Волгоград (844)278-03-48
Вологда (8172)26-41-59
Воронеж (473)204-51-73
Екатеринбург (343)384-55-89
Иваново (4932)77-34-06
Ижевск (3412)26-03-58
Иркутск (395) 279-98-46

Казань (843)206-01-48
Калининград (4012)72-03-81
Калуга (4842)92-23-67
Кемерово (3842)65-04-62
Киров (8332)68-02-04
Краснодар (861)203-40-90
Красноярск (391)204-63-61
Курск (4712)77-13-04
Липецк (4742)52-20-81
Магнитогорск (3519)55-03-13
Москва (495)268-04-70
Мурманск (8152)59-64-93
Набережные Челны (8552)20-53-41
Нижний Новгород (831)429-08-12

Новокузнецк (3843)20-46-81
Новосибирск (383)227-86-73
Омск (3812)21-46-40
Орел (4862)44-53-42
Оренбург (3532)37-68-04
Пенза (8412)22-31-16
Пермь (342)205-81-47
Ростов-на-Дону (863)308-18-15
Рязань (4912)46-61-64
Самара (846)206-03-16
Санкт-Петербург (812)309-46-40
Саратов (845)249-38-78
Севастополь (8692)22-31-93
Симферополь (3652)67-13-56

Смоленск (4812)29-41-54
Сочи (862)225-72-31
Ставрополь (8652)20-65-13
Сургут (3462)77-98-35
Тверь (4822)63-31-35
Томск (3822)98-41-53
Тула (4872)74-02-29
Тюмень (3452)66-21-18
Ульяновск (8422)24-23-59
Уфа (347)229-48-12
Хабаровск (4212)92-98-04
Челябинск (351)202-03-61
Череповец (8202)49-02-64
Ярославль (4852)69-52-93

Киргизия (996)312-96-26-47

Казахстан (772)734-952-31

Таджикистан (992)427-82-92-69

Introduction

Thank you for purchasing an EQUO Series ZN-KMX21 Power Sensor Station.

This manual describes the information on the functions, performance and usage required to use the Power Sensor Station.

Please observe the following when using the Power Sensor Station:

- This product must be handled by specialists with electrical knowledge.
- Read this User's Manual thoroughly to be familiar with the product beforehand for correct operation.
- Keep this manual for future reference.

Trademarks

- Microsoft and Windows are registered trademarks or trademarks of Microsoft Corporation in the United States and other countries.
- Other company names and product names are registered trademarks or trademarks of each company.

Manual Types and Their Usage

The major contents of the manuals are shown below. Select and read the manual according to your need.

Included Manuals (Print)

Instruction Sheet

Describes the information to ensure the safe and proper use of the product, and information regarding ratings, performance and installation.

Startup Guide

Describes the basic procedures including the package content check, assembly, setting operation, recording operation and data display.

Manuals available from Website (PDF data)

User's Manual (This document)

Describes information to ensure the safe and proper use of the product

Describes package content items and detailed procedures for assembly, setting operation, recording operation and data display

Product specifications

Other necessary information required to use the Power Sensor Station ZN-KMX21

Station Utility User's Manual

Describes the information of accessory, functions and operation of the PC software Station Utility.

Terms and Conditions Agreement

Warranties.

(a) Exclusive Warranty. Omron's exclusive warranty is that the Products will be free from defects in materials and workmanship for a period of twelve months from the date of sale by Omron (or such other period expressed in writing by Omron). Omron disclaims all other warranties, express or implied.

(b) Limitations. OMRON MAKES NO WARRANTY OR REPRESENTATION, EXPRESS OR IMPLIED, ABOUT NON-INFRINGEMENT, MERCHANTABILITY OR FITNESS FOR A PARTICULAR PURPOSE OF THE PRODUCTS. BUYER ACKNOWLEDGES THAT IT ALONE HAS DETERMINED THAT THE PRODUCTS WILL SUITABLY MEET THE REQUIREMENTS OF THEIR INTENDED USE.

Omron further disclaims all warranties and responsibility of any type for claims or expenses based on infringement by the Products or otherwise of any intellectual property right.

(c) Buyer Remedy. Omron's sole obligation hereunder shall be, at Omron's election, to (i) replace (in the form originally shipped with Buyer responsible for labor charges for removal or replacement thereof) the non-complying Product, (ii) repair the non-complying Product, or (iii) repay or credit Buyer an amount equal to the purchase price of the non-complying Product; provided that in no event shall Omron be responsible for warranty, repair, indemnity or any other claims or expenses regarding the Products unless Omron's analysis confirms that the Products were properly handled, stored, installed and maintained and not subject to contamination, abuse, misuse or inappropriate modification. Return of any Products by Buyer must be approved in writing by Omron before shipment. Omron Companies shall not be liable for the suitability or unsuitability or the results from the use of Products in combination with any electrical or electronic components, circuits, system assemblies or any other materials or substances or environments. Any advice, recommendations or information given orally or in writing, are not to be construed as an amendment or addition to the above warranty.

See <http://www.omron.com/global/> or contact your Omron representative for published information.

Limitation on Liability; Etc.

OMRON COMPANIES SHALL NOT BE LIABLE FOR SPECIAL, INDIRECT, INCIDENTAL, OR CONSEQUENTIAL DAMAGES, LOSS OF PROFITS OR PRODUCTION OR COMMERCIAL LOSS IN ANY WAY CONNECTED WITH THE PRODUCTS, WHETHER SUCH CLAIM IS BASED IN CONTRACT, WARRANTY, NEGLIGENCE OR STRICT LIABILITY.

Further, in no event shall liability of Omron Companies exceed the individual price of the Product on which liability is asserted.

Suitability of Use.

Omron Companies shall not be responsible for conformity with any standards, codes or regulations which apply to the combination of the Product in the Buyer's application or use of the Product. At Buyer's request, Omron will provide applicable third party certification documents identifying ratings and limitations of use which apply to the Product. This information by itself is not sufficient for a complete determination of the suitability of the Product in combination with the end product, machine, system, or other application or use. Buyer shall be solely responsible for determining appropriateness of the particular Product with respect to Buyer's application, product or system. Buyer shall take application responsibility in all cases.

NEVER USE THE PRODUCT FOR AN APPLICATION INVOLVING SERIOUS RISK TO LIFE OR PROPERTY OR IN LARGE QUANTITIES WITHOUT ENSURING THAT THE SYSTEM AS A WHOLE HAS BEEN DESIGNED TO ADDRESS THE RISKS, AND THAT THE OMRON PRODUCT(S) IS PROPERLY RATED AND INSTALLED FOR THE INTENDED USE WITHIN THE OVERALL EQUIPMENT OR SYSTEM.

Programmable Products.

Omron Companies shall not be responsible for the user's programming of a programmable Product, or any consequence thereof.

Performance Data.

Data presented in Omron Company websites, catalogs and other materials is provided as a guide for the user in determining suitability and does not constitute a warranty. It may represent the result of Omron's test conditions, and the user must correlate it to actual application requirements. Actual performance is subject to the Omron's Warranty and Limitations of Liability.

Change in Specifications.

Product specifications and accessories may be changed at any time based on improvements and other reasons. It is our practice to change part numbers when published ratings or features are changed, or when significant construction changes are made. However, some specifications of the Product may be changed without any notice. When in doubt, special part numbers may be assigned to fix or establish key specifications for your application. Please consult with your Omron's representative at any time to confirm actual specifications of purchased Product.

Errors and Omissions.

Information presented by Omron Companies has been checked and is believed to be accurate; however, no responsibility is assumed for clerical, typographical or proofreading errors or omissions.

Precautions on Safety

● Meanings of Signal Words





For the safe operation of ZN-KMX21, this operation manual indicates the precautions by using the following marks and symbols. The precautions given here contain important information related to safety, and therefore must be observed.

The marks and symbols for the safety precautions are as follows:



 WARNING	<p>Indicates a potentially hazardous situation which, if not avoided, will result in minor or moderate injury, or may result in serious injury or death. Additionally there may be significant property damage.</p>
---	---



 CAUTION	<p>Indicates a potentially hazardous situation which, if not avoided, may result in minor or moderate injury or in property damage.</p>
---	---

● Meaning of Precaution Symbols

	<p>● Mandatory Requirement Indicates a general mandatory requirement.</p>
	<p>● Prohibition Indicates general prohibition.</p>
	<p>● Electric Shock Warning Warns against an electric shock under specific conditions.</p>
	<p>● Explosion Warning Warns against an explosion under specific conditions.</p>
	<p>● Disassembly Prohibition Indicates the possibility of accidents such as an electric shock caused by unit disassembly.</p>

● Warning Indications

 WARNING	
<p>The mounting magnets (separately sold) for the product have strong magnetism. If the product is mounted using these magnets, anyone wearing a heart pacemaker must not operate the product; or the product must not be in proximity of such a person.</p>	
<p>This product contains a lithium battery. Serious injury may occur due to fire or explosion. Do not attempt to disassemble the product, deform it by applying pressure, heat it in a high temperature (100°C or more), or burn it for disposal.</p>	

 CAUTION	
<p>Tighten the terminal screws at a recommended torque: 0.69 to 0.88N · m. Make sure that the screws are not slanted away from the center after tightened.</p>	
<p>A minor or moderate injury or property damage may occur due to explosion. Do not use the product in an environment containing an inflammable or explosive gas.</p>	
<p>An electric shock or minor injury as well as fire or unit malfunction may occur. Do not attempt to disassemble, repair or modify the product.</p>	

Precautions for Safe Use

Observe the following precautions to ensure safe operation:

- Do not install the product in the places subject to exposure to water, oil, or chemical splashes.
- When using an AC adapter, use only the provided AC adapter.
- If a voltage that exceeds the rated voltage is applied to the AC adapter, smoke may occur. Do not connect a power supply that exceeds the rated voltage. In a situation where a voltage higher than the rating is applied, use protective equipment so that the power supply voltage does not exceed the rated voltage.
- Do not use the product in a safety circuit for nuclear or life-support systems.
- Dispose of the product as industrial waste.
- Do not apply strong shock to the product, or it may cause damage or malfunction. It is recommended to screw the product to mount it on the wall. Stop using the product when strong shock is applied.
- When inserting or removing an SD memory card, securely hold the product to prevent damage from dropping. Do the same when inserting or detaching an AC adapter, alarm output cable, or sensor connector.
- Do not expose the product close to magnetic products (e.g. magnetic cards), or sensitive electronics equipment (e.g. computers or clocks), when using the mounting magnets.
- Small pieces may be chipped off when using the mounting magnets. In case the pieces get into your eyes, consult a medical doctor immediately.
- When using the mounting magnets to install the product, take caution not to allow a finger to be caught between the product(s) and the magnetic surface.
- Do not install the product at a high place when using the mounting magnets.
- Apply an appropriate load to the alarm output terminals to prevent smoke.
- If liquid crystal leaks because of the damage of the LCD panel, be careful not to touch, inhale or swallow it. In case liquid crystal gets into your mouth or comes in contact with your skin, consult a medical doctor.
- Take measures for anti-static electricity (e.g. touching grounded metal object) when handling the product.

Precautions for Correct Use

1. Avoid installing the product in the following places:

- Places exceeding the rated ambient temperature
- Places exposed to extreme temperature changes (where condensation occurs)
- Places subject to relative humidity exceeding the rated humidity range
- Places subject to corrosive or flammable gases
- Places subject to mist, droplets, coarse particles, fiber, salt, metal dust, or large amount of particles
- Places subject to direct shock or vibration
- Places subject to direct sunlight
- Places subject to exposure to water, oil, or chemical splashes
- Places subject to strong magnetic field or electric field
- Outdoors

2. Wiring

- Wire the product cable separately from high-voltage or power lines. Placing them in the same wiring or the same duct may cause induction, resulting in the product malfunction or damage.
- Make sure that the I/O terminals are inserted or removed with the power turned OFF. Doing this with the power ON may result in a malfunction.
- When using the provided DC cable, connect a wire with white line to the power supply (24 VDC \pm 3%), and connect a wire without the line to 0 V.

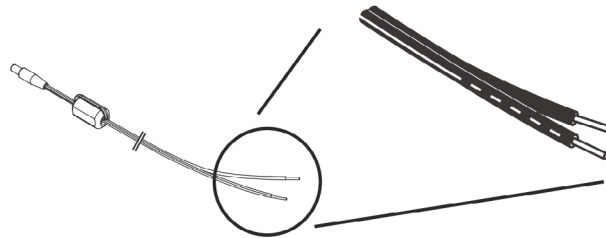

- Mounting a ferrite core can reduce noise affecting to or affected by other devices when supplying power with the DC cable. When using the provided DC cable, wind the provided ferrite core as shown below.

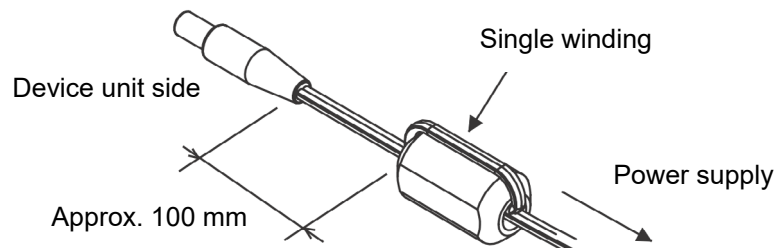

3. Mounting Screw Holes

- The screw holes provided on the product are M3 and 4 mm deep. Do not screw deeper than 4 mm, which may damage the product.

4. Operation

When using the product, also read KM Series Power Sensor/Monitor instruction sheets for necessary information relevant to the product.

- The Power Sensors/Monitors that can be connected to the product are KM20-B40-FLK, KM50-C, KM50-E, KM100, KM-N1-FLK, KM-N2-FLK and KM-N3-FLK.
- To directly connect KM-N1-FLK, KM-N2-FLK and KM-N3-FLK to the product, please purchase a separately sold dedicated connection cable ZN9-KMC30-N.

5. Batteries cannot be used with this product. Do not attempt to open the product rear cover for mounting batteries.



6. Long Term Storage

If the product will not be used for a long period of time, store the product in the location where the temperature is not too high. Otherwise the built-in battery may drain faster.

How to Read This Manual

■ Symbols Used in this Manual

Menu items that are displayed on the screen, and windows, dialog boxes and other GUI elements displayed on the PC are indicated enclosed by brackets "[]".

■ Marks Used in this Manual

Important : Indicates essential information on the product operation and functions, which requires special attention or caution.

Note : Shows operational tips or related useful information.

Table of Contents

Introduction	i
Table of Contents	x
1. Product Overview	1-1
1.1 Features and Functions	1-1
(1) Easy Multi-point Data Acquisition	1-1
(2) Recording to an SD Memory Card.....	1-1
(3) Network Connection	1-1
(4) Graph Display and Data Processing Software	1-1
(5) Alarm Output.....	1-1
1.2 Configuration.....	1-2
1.2.1 Standalone	1-2
1.2.2 Network Connection	1-2
(1) Remote Setting and Control from PC	1-2
(2) Measured Data Recording to PC.....	1-2
1.3 Multi-point Power Measurement	1-3
1.4 Setup and Operation Procedure	1-4
1.4.1 Standalone Operation	1-4
1.4.2 Operation via Network	1-5
2. Part Name and Function	2-1
2.1 Display Unit	2-1
2.2 Control Unit	2-3
2.2.1 Control Key	2-3
2.2.2 Reset Switch	2-3
2.2.3 SD Inserting/Removing SD Card	2-3
(1) Inserting SD Card	2-4
(2) Removing SD Card.....	2-4
2.3 Input/Output Specifications	2-5
2.3.1 Alarm Output.....	2-5
(1) Alarm Output Terminals	2-5
(2) Output Specifications	2-5
3. Check and Preparation	3-1
3.1 Checking the Package Contents.....	3-1

3.2	Preparing the Required Items	3-1
(1)	Common	3-1
(2)	Network Connection	3-1
3.3	Configuring the Unit	3-2
3.3.1	Connecting Power Sensor/Monitor (KM Series).....	3-2
(1)	Power Sensor/Monitor Settings (KM Series).....	3-2
(2)	Power Sensor/Monitor Connection (KM Series).....	3-3
3.3.2	Using Alarm Function.....	3-4
3.3.3	Preparing Power Supply	3-5
(1)	Connecting to Power Supply.....	3-5
3.3.4	Checking Operation	3-6
3.4	Station Utility PC Software Overview and Preparation	3-7
3.4.1	Overview	3-7
(1)	Setting Tool	3-7
(2)	Logging Tool.....	3-7
(3)	Momentary Value Display (SD Viewer ES).....	3-7
(4)	Integration and Summation Tool (Energy Viewer)	3-7
3.4.2	Installation.....	3-7
3.5	Setting Measurement Conditions.....	3-8
(1)	Switching to "FUN" Mode	3-8
(2)	Setting the Number of Power Sensor/Monitor Units to be Connected (Example: 5 Units)	3-8
3.6	Connecting to Network.....	3-9
3.6.1	Preparation	3-9
3.6.2	Setting Power Sensor Station IP Address.....	3-10
(1)	Switching to "FUN" Mode	3-10
(2)	Setting ETC and IP to "DISP"	3-11
(3)	Changing IP Address (from factory default: 192.168.0.20 to 192.168.0.21)	3-12
3.6.3	Setting the PC IP Address	3-13
(1)	Windows XP.....	3-13
(2)	Windows Vista	3-16
(3)	Windows 7	3-19
3.6.4	Connecting LAN Cable	3-22
3.7	Mounting the Unit.....	3-22
3.7.1	Free-stand Installation	3-22
3.7.2	Securing with Mounting Screws.....	3-23
3.7.3	Screw Hook Mounting.....	3-24
3.8	Power Sensor/Monitor Remote Setting (KM Series)	3-25
4.	Setting the Unit (Unit Operation)	4-1

4.1	Setting Procedure and Operation Modes	4-1
4.2	Settings (FUN Mode Operation)	4-2
4.2.1	Setting Item List	4-2
4.2.2	Selecting "FUN" Operation Mode	4-3
4.2.3	Selecting Items	4-4
4.2.4	Definition of Items	4-5
(1)	Recording Interval (CYCLE)	4-5
(2)	Number of Power Sensor/Monitor Units Connected (UNIT).....	4-7
(3)	Recording Mode (REC)	4-8
(4)	Integrated Power Reset Interval (INTEG).....	4-8
(5)	Initialization (INIT).....	4-8
(6)	Others (ETC).....	4-10
(7)	Reading Setting Data (RESTR).....	4-10
(8)	Writing the Setting Data (BCKUP).....	4-11
(9)	Setting Clock (CLOCK).....	4-11
(10)	YEAR/MONTH/DAY/TIME Setting.....	4-12
(11)	Setting IP Address (IP)	4-12
(12)	IP Address and Subnet Mask (IP 1 to IP 4, SUB 1 to SUB 4)	4-13
(13)	Rate/CO ₂ Conversion Value Setting (RATE)	4-13
(14)	Conversion Unit Setting (CONV)	4-13
(15)	Offset Unit No. (UTOFS).....	4-14
(16)	Power Failure REC Restoration (REREC)	4-14
4.2.5	Changing the Set Value	4-15
(1)	Changing Option Type Item Value (Example: CYCLE)	4-15
(2)	Changing Numeric Input Type Item Value (Example: YEAR).....	4-16
4.3	Settings (THR Mode Operation)	4-17
4.3.1	Setting Item List	4-17
4.3.2	Selecting "THR" Operation Mode	4-18
4.3.3	Selecting Items	4-18
4.3.4	Definition of Items	4-18
(1)	Integrated Power Upper Limit Threshold (INT H).....	4-18
4.3.5	Changing the Set Value	4-18
4.4	Copying Setting Data for Multiple Station Units	4-19
5.	Measurement and Recording (Unit Operation)	5-1
5.1	Overview	5-1
5.2	Selecting Operation Mode	5-1
5.3	Screen Transition in RUN Mode	5-2
5.4	Starting/Stopping Recording	5-4

5.4.1	Starting Recording	5-4
5.4.2	Stopping Recording	5-4
5.5	Outputting File to SD Card	5-5
5.6	Cancelling Retained Alarm	5-5
6.	Ratings and Performance.....	6-1
Appendix		Appendix-1
	Error Display List.....	Appendix-1
	Character Display List.....	Appendix-3
	SD Memory Card Folder Structure	Appendix-4
	Calibration	Appendix-5
	Installation Diagram	Appendix-6

Revision History

1. Product Overview

1.1 Features and Functions

(1) Easy Multi-point Data Acquisition

The ZN-KMX21 Power Sensor Station provides the measurement and recording of power consumption at multiple points. Individual measured values are added to total sums, which can be checked at operation sites. The station can be connected to up to 31 Power Sensor/Monitor units, whose momentary power, integrated power, power factor, and pulse count values can be independently recorded. Power data acquisition at operation sites now becomes easy, contributing to enhanced energy-saving efficiency.

(2) Recording in SD Memory Card

The measured data can be recorded in the Power Sensor Station. Up to approx. 200 data items* can be accumulated in the internal memory at the maximum load, and approx. 6800 items at the minimum load, which enables the station to continue data recording even at an emergency network failure. The station allows its data accumulated in the internal memory to be output to an SD memory card in CSV format without stopping measurement, thus making continuous recording for long hours possible.

* The recordable shortest time in the internal memory is approximately 1 hour and 20 minutes. Use an SD memory card for longer time of recording.

(3) Network Connections

The measured values obtained from multiple Power Sensor Station units can be recorded to a PC connected to the stations via LAN cable by using the PC software. Individual Power Sensor Stations can be controlled from the PC to check or change their settings as well as start/stop the recording. (Refer to "Station Utility User's Manual" for details.)

Online real-time control of the entire network is also possible from the PC by using Wave Inspire ES, separately sold software.

(4) Graph Display and Data Processing Software

The data output to an SD card or recorded to a PC through LAN connection can be displayed in graphs or processed online by using the PC software. The data items in different periods can be combined or multiple station data can be displayed simultaneously side by side on the screen. (Refer to "Station Utility User's Manual" for details.)

(5) Alarm Output

Alarm output terminals are provided on the Power Sensor Station. The alarm is output when the measured power value exceeds the upper limit. This feature provides 'visualization' of the power limit, allowing the operator to quickly handle problems.

1.2 Configuration

This product can be used in the following two types of configuration.

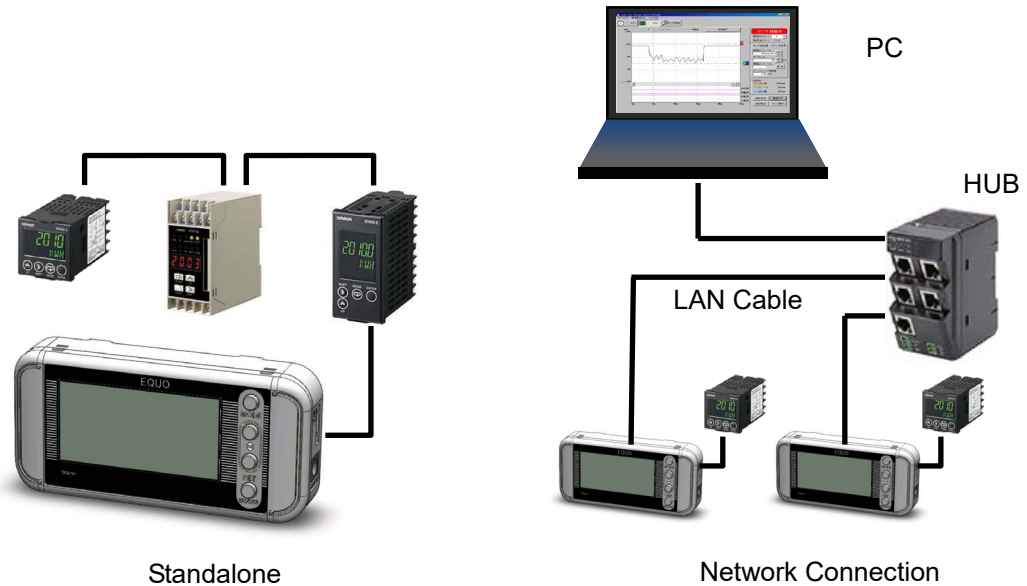

1.2.1 Standalone

The Power Sensor Stations can be operated standalone without connecting them to a network. The measured data is recorded in the internal memory and can be transferred to a PC via an SD memory card.

The recorded data in an SD memory card can be displayed in graphs using the SD Viewer ES or Energy Viewer, software included in Station Utility. (Refer to the "Station Utility User's Manual" for details of the PC software.)

1.2.2 Network Connection

The Power Sensor Stations can be connected to a PC via LAN. The following operations are available by using the PC software. (Refer to "Station Utility User's Manual" for the details of the PC software.)

(1) Remote Setting and Control with PC

Settings on Power Sensor Stations (except for IP address settings) and recording start/stop operation can be controlled remotely from the PC by using the Station Utility (PC software) setting tool.

(2) Recording Measured Data Recording in PC

The measured data on Power Sensor Stations can be recorded in the PC using the Station Utility (PC software) logging tool. The recorded data can be displayed in graphs offline on the SD Viewer ES or Energy Viewer included in the Station Utility.

Note

Up to 100 Power Sensor Station units can be connected to a PC (Up to 1024 channels are supported).

Up to 31 units of Power Sensors/Monitors (KM series) can be connected to a single Power Sensor Station unit.

1.3 Multi-point Power Measurement

- By connecting multiple KM series Power Sensors/Monitors (sold separately) to a Power Sensor Station as its lower units, the momentary power and integral power consumption obtained via the individual units can be displayed both as the individual values and the total sum of individual values.
- Momentary power values are displayed all the time while the power is ON.
- Integral power consumption values are constantly calculated only during the recording, which has been started by (holding) the SET/REC/STOP key. The display is constantly updated. When the recording is stopped, the values at the time of the stop are displayed.
- Values measured at multiple points can be logged to a single CSV file record.

1.4 Setup and Operation Procedure

1.4.1 Standalone Operation

Check the package contents
⇒3.1 Checking the Package Contents

Check the required items
⇒3.2 Preparing the Required Items

Connect KM series power sensors/monitors; alarm output terminals and prepare the power supply
⇒3.3 Configuring the Unit

Install the Station Utility PC software
⇒"Station Utility User's Manual": 1. Overview and Preparation

Set the measurement conditions
⇒3.5 Setting the Measurement Conditions

Mount the product
⇒3.7 Mounting the Unit

Make settings directly on the unit
⇒4 Setting the Unit (Unit Operation)

Record data by direct unit operation
⇒5 Measurement and Recording (Unit Operation)

Analyze short-period recording data
⇒"Station Utility User's Manual": 4. Momentary Value Display

Analyze long-period recording data
⇒"Station Utility User's Manual": 5. Integration and Summation

1.4.2 Operation via Network

Check the package contents
→ 3.1 Checking the Package Contents

Check the required items
→ 3.2 Preparing the Required Items

Connect KM series power sensors/monitors; alarm output terminals and prepare the power supply
→ 3.3 Configuring the Unit

Install the Station Utility PC software
→ "Station Utility User's Manual": 1. Overview and Preparation

Set the measurement conditions
→ 3.5 Setting the Measurement Conditions

Connect the product to a network
→ 3.6 Connecting to Network

Mount the product
→ 3.7. Mounting the Unit

Record data in PC
→ "Station Utility User's Manual": 3. Recording in PC

Remotely record data in the unit
→ "Station Utility User's Manual": 2. Remote Setting and Operation Control from PC

Remotely set Power Sensor/Monitor
→ 3.8. Power Sensor/Monitor (KM Series) Remote Setting

Analyze short-period recording data
→ "Station Utility User's Manual": 4. Momentary Value Display

Analyze long-period recording data
→ "Station Utility User's Manual": 5. Integration and Summation

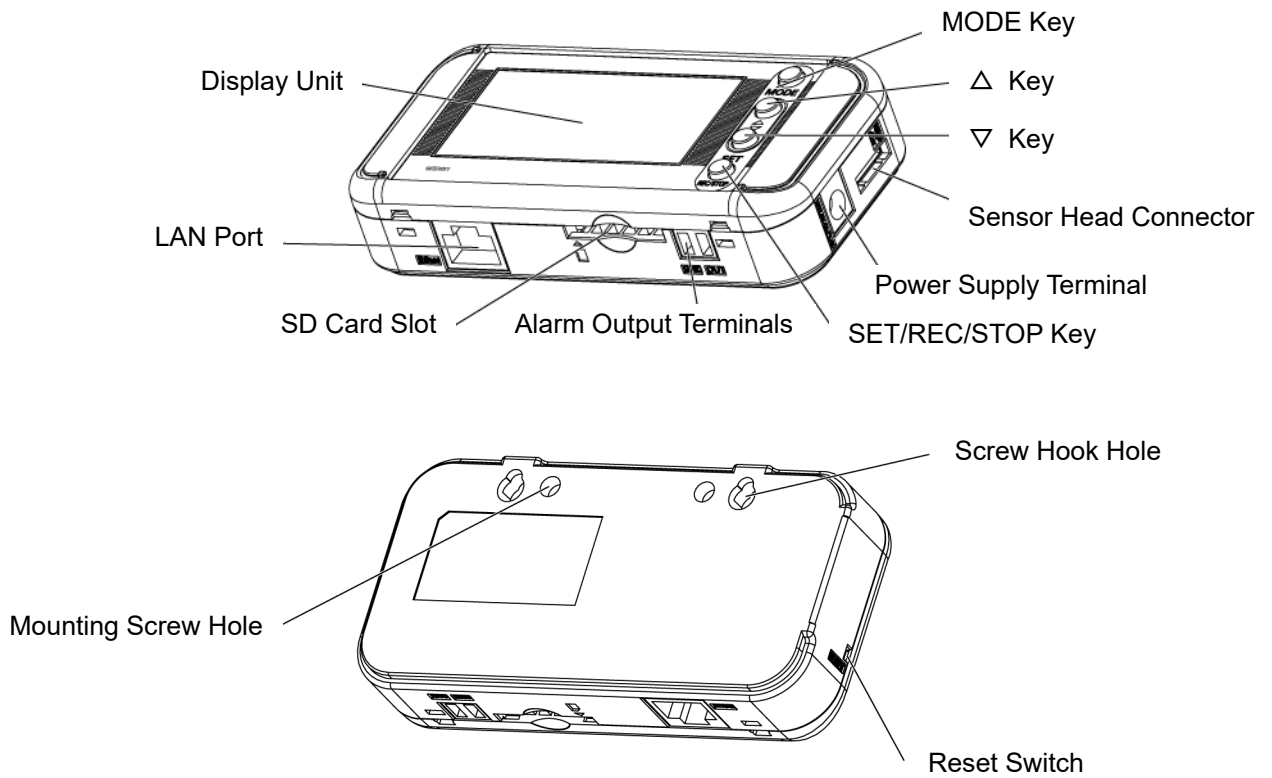

2. Part Name and Function



2.1 Display Unit



Display Unit

Indicator Definition	
Indicator	Definition/Function (When Displayed)
	An Integral power consumption reset interval is set. The setting is OFF when this is not displayed.
	Communication via LAN cable is in process.
LAN	A LAN cable is connected and network communication is ready.
REC	Data is being recorded in the internal memory.
SD	An SD memory card is inserted. The SD card is being accessed when this is blinking.
ALM	The total sum of integral power consumptions have exceeded the upper threshold value.
	Power is being supplied to the unit.
Hi	Indicates the upper limit threshold value.
MAX	Indicates the maximum momentary power total sum.
MIN	Indicates the minimum momentary power total sum.
AVE	Indicates the average momentary power total sum.
RUN	The unit is currently operating in RUN mode.
FUN	The unit is currently operating in FUN mode.
THR	The unit is currently operating in THR mode.

Refer to the Appendix for the definitions of alphabetical, numeric and principal message displays.

Refer to: Appendix, "Character Display List"

2.2 Control Unit

2.2.1 Control Key

Name	Function
MODE Key	Switches the operation mode. Resets an alarm or error (Long press). Cancels the setting before applying it.
Item Selection Key (△ Key)	Moves the setting items (Upward). Switches the display. Changes the setting value (Incremental).
Item Selection Key (▽ Key)	Moves the setting items (Downward). Switches the display. Changes the setting value (Decremental).
SET/REC/STOP Key	Applies the setting value or changes. Starts/stops recording (Long press). Saves the recorded data to the SD memory card.

2.2.2 Reset Switch

The reset switch is provided inside the aperture on the unit left side. Use a thin-tipped object (insulator) such as a pen to press the switch. The unit resets itself.

Do not touch the front keys when the unit is in reset process until the power value is displayed.

Reset operation does not initialize the settings made on the unit.

2.2.3 SD Inserting/Removing Memory SD Card

This product provides an SD card slot for SD memory card operation such as writing the measured data recorded in the internal memory to the card, and writing/reading the setting data to/from the card.

Important

- Secure the unit firmly when inserting/removing an SD card. It is essential especially when the unit is mounted using the screw hook holes. If the card is inserted/removed without securing the unit, the unit may fall of the hooks and drop on the floor, and damaging itself.
- Do not remove the SD memory card when the "SD" display is blinking. Doing so may destroy the data in the SD memory card.
- Do not touch the metal terminal of the SD memory card.
- Do not bend the SD memory card.
- Avoid static electricity when inserting/removing an SD memory card.
- Do not make the write-protection of the SD memory card unwritable.

(1) Inserting an SD Memory Card

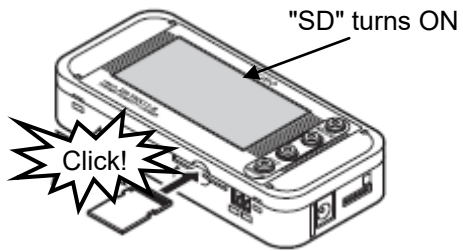

- (1) Insert an SD memory card into the SD card slot with the metal terminal facing up.
- (2) Push the card inward until it clicks.
- (3) "SD" appears on the display.

(2) Removing the SD Memory Card

- (1) Push the inserted SD memory card inward until it clicks.
- (2) Stop pushing and let the card pop out. Be careful not to drop it.
- (3) "SD" on the display disappears.

Important

- If an SD memory card is unformatted, format it before inserting it into the SD card slot.
- For SD memory card format software distribution page, refer to the following URL.
https://www.sdcard.org/downloads/formatter_4/index.html

2.3 Input/Output Specifications

2.3.1 Alarm Output

(1) Alarm Output Terminals

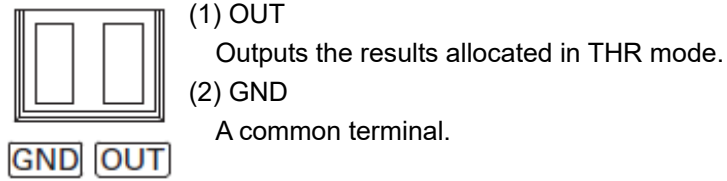

The terminal names are inscribed on the unit.

Use the provided alarm output connector for wiring.

(2) Output Specifications

External Power Supply Voltage	12 to 24 VDC $\pm 10\%$
Load Current	Max. 45 mA
ON Residual Voltage	Max. 1.2 V
OFF Leakage Current	Max. 0.1 mA
Internal Circuit Diagram	

Important

Do not directly connect the external power supply between OUT and GND.

Be sure to connect a load.

3. Check and Preparation

3.1 Checking the Package Contents

This product package includes the following items:

<input type="checkbox"/> Main Unit ZN-KMX21	1
<input type="checkbox"/> AC Adapter or DC Cable	1
<input type="checkbox"/> Power Sensor Station Cable	1
<input type="checkbox"/> Alarm Output Connector	1
<input type="checkbox"/> Instruction Sheet	1
<input type="checkbox"/> Startup Guide	1

3.2 Preparing the Required Items

The following items are required to use this product.

(1) Common

KM Series Power Sensors/Monitors

- KM100 Power Monitor
- KM20-B40 Power Monitor
- KM50-□ Power Monitor
- KM-N1-FLK Power Monitor
- KM-N2-FLK Power Monitor
- KM-N3-FLK Power Monitor

Any of them in 1 to 31 units (Sold separately)

PC (personal computer) for the PC software 1

Refer to: 3.4.2 Operating Environment

SD Memory Card (SDHC compatible) 1

Used to save measured data (in network and standalone operation) or to relocate the data (when recording in a Power Sensor Station unit)

(2) Network Connection

LAN Cable (10BASE-T or 100BASE-TX; Safety Category 5e or higher; Straight Type)

LAN Connection HUB (for 10BASE-T or 100BASE-TX)

Note

Generally, the Power Sensor Stations should be connected to a PC via HUB.

3.3 Configuring the Unit

3.3.1 Connecting Power Sensor/Monitor (KM Series)

(1) Power Sensor/Monitor Settings (KM Series)

Match the communication settings of all the Power Sensors/Monitors to the Power Sensor Station settings as shown below. For example, note that the communication speed must be set to 38.4k, which is not identical to the default settings.

Unit No.	Assign unique consecutive numbers.
Communication Speed	38.4 kbps
Data Bit Length	7 bit (Factory default)
Stop Bit Length	2 bit (Factory default)
Vertical Parity	EVEN (Factory default)
Transmission Waiting Time	20 ms (Factory default)

■ Individual Power Sensor/Monitor Type Setting

(1) The first unit only requires the following setting if its factory settings have not been changed.

<KM50-□>

Power ON → (Meas. Mode) → (Setting Mode) → (Comm. Setting Mode)

→ (Comm. Speed Setting) → Set to "38.4"

Twice 

MODE Hold the key ENTER

UP To Change
ENTER To Apply

<KM20>

Turn ON the DIP switches 2 and 3 (COMMUNICATION SETTING SW). (See below)

COMMUNICATION SETTING SW

ON OFF 

1 10

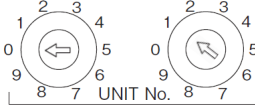

Unit No.: 01

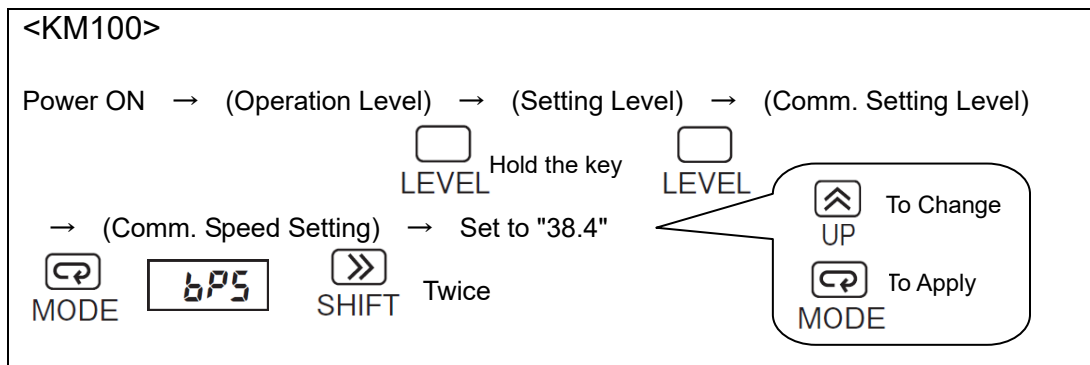

(2) Make the same setting on the other units (Unit No. 2, 3, 4...).

The Unit No. setting is also required for the other units in addition to the setting above.

If measurement is performed for other circuit than three-phase, three-wire system, specific circuit type settings are required.

Refer to the relevant Power Sensor/Monitor instruction sheet for details.

(2) Power Sensor/Monitor Connection (KM Series)

Up to 31 units of Power Sensors/Monitors can be connected to a single Power Sensor Station.

Connect Power Sensors/Monitors to a Power Sensor Station as shown below, in a daisy chain.

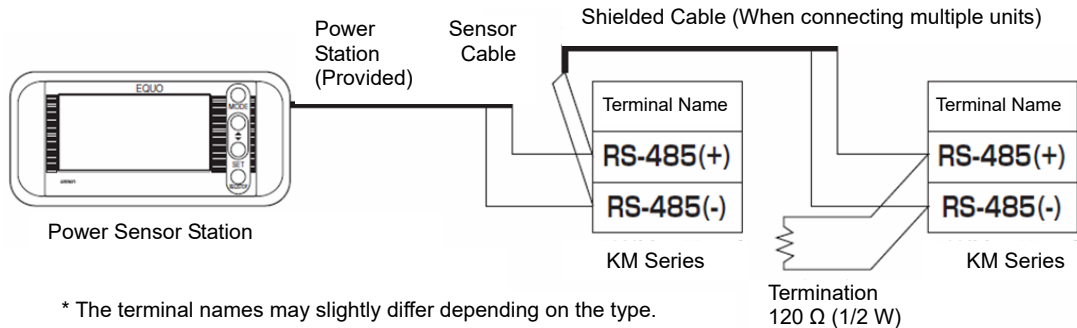

(1) Connect the provided Power Sensor Station cable to the station unit.

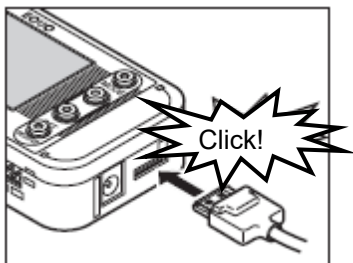

Insert the cable into the sensor head connector until it clicks.

(2) Connect the first Power Sensor/Monitor unit to the Power Sensor Station.

Connect the Power Sensor/Monitor to the provided Power Sensor Station cable.

(3) When connecting multiple Power Sensor/Monitor units, connect a shielded cable

between Power Sensor/Monitor units.

Important

Match the polarities between the crimp terminals and terminal holes when connecting the units.

Shielded cables must be provided by the user.

- (4) Provide a 120 Ω (1/2 W) termination between the RS-485 terminals on the last Power Sensor/Monitor unit.

The shielded cable for the termination must be provided by the user.

Refer to the relevant Power Sensor/Monitor operation manual for their detailed operation.

3.3.2 Using Alarm Function

Use the provided alarm output connector to connect the OUT and GND alarm output terminals to the load according to the output specifications.

Refer to: 2.3.1 Alarm Output

3.3.3 Preparing Power Supply

AC or DC power supply is required to operate this product.

(1) Connecting to Power Supply

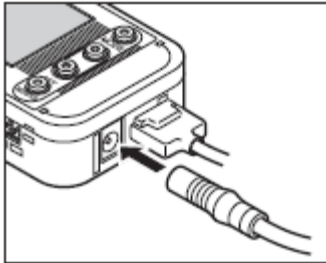

(1) Insert the plug of the AC adapter or DC cable plug into the Power Supply terminal.

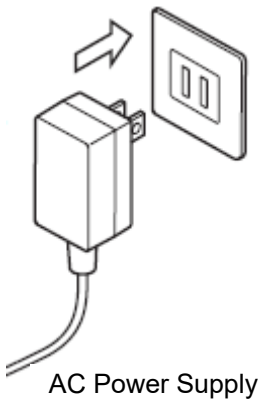

(2) Connect the AC plug of the AC adapter to an outlet (100 VAC to 240 VAC) when using AC power supply. To use DC power supply, connect the white-lined wire of the DC cable to the power input (24 VDC) and the non-lined wire to 0V.



Important

- Use the provided AC adapter when using AC power supply.
- Use the provided DC cable when using DC power supply.
- Batteries cannot be used. Do not open the unit cover to attempt to install the batteries.

Note

- The unit does not have a power switch. The unit starts operation immediately when the power is supplied.

3.3.4 Checking Operation

After the power is turned ON, the type name and version are displayed on the display section for a while. The power information appears on the display, after the unit checks the connection with Power Sensor/Monitor units.

Press ∇ or Δ keys to change the display while the "RUN" indicator at the bottom of the display is ON.

Refer to: 5.3 Screen Transition in RUN Mode

Important

- Do not touch any front keys until the power value appears on the display after the power is ON.
- 20 seconds or more waiting time is required until the power information appears, because the unit needs to wait for Power Sensor/Monitors to start up.
- The connected Power Sensor/Monitor units must be turned ON before the Power Sensor Station. If the order is reversed, the station may not correctly recognize the type names of the Power Sensor/Monitor units, which may result in power data acquisition failures.
- The "ALLOK" indication appears when the unit normally recognizes all the connected Power Sensor/Monitor units.

If the connection is not normally recognized, investigate the cause by checking wirings, communication conditions, unit No. settings or other related issues.

3.4 Station Utility PC Software Overview and Preparation

3.4.1 Overview

This product includes PC software Station Utility, which consists of four principal functions. Refer to the "Station Utility User's Manual" for details.

(1) Setting Tool

This function provides remote operations such as setting the measurement condition (except for some settings), starting and stopping recording of the data to the Power Sensor Stations.

(2) Logging Tool

This function acquires the measured data of the Power Sensor Stations in a PC via network. The measured data in the stations can also be displayed on the PC.

(3) Momentary Value Display (SD Viewer ES)

The tool provides the graph displays offline of the data acquired in the PC using the logging tool or the Power Sensor Station data recorded in the SD memory card. It can also combine multiple data items recorded in different periods or provide a concurrent display of multiple data items recorded in different periods or with different Power Sensor Stations.

(4) Integration and Summation Tool (Energy Viewer)

The tool provides summations of data acquired to the PC using the logging tool or Power Sensor Station data recorded to the SD memory card. The unit of summation periods can be changed and pre-selected summation items on multiple Power Sensor/Monitor units can be displayed in graphs with this tool. It also provides the comparison of the current data with past summation data or data recorded on other Power Sensor Station.

3.4.2 Installation

Install Station Utility on the PC.

Refer to the "Station Utility User's Manual": 1.3 Operating Environment and 1.4 Installation, for the installation procedure.

3.5 Setting Measurement Conditions

Set the number of Power Sensor/Monitor units to be connected to the Power Sensor Station.

Note

Refer to the sections below for details on messages displayed on the display unit and operational key functions.

Refer to: 2.1 Display Unit, 2.2 Control Unit, and 4.2 Settings (FUN Mode Operation)

(1) Switching to "FUN" Mode

"FUN" mode should be entered for setting measurement conditions. Press the MODE key until the "FUN" indicator at the lower right of the display starts blinking.

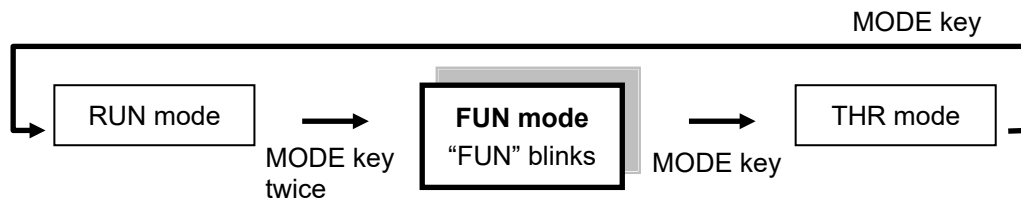

(2) Setting the Number of Power Sensor/Monitor Units to be Connected (Example: 5 Units)

Display (Upper/Lower)	Operation
CYCLE 10s ("FUN" Blinking)	Press the ∇ or \triangle key until "NODE" appears at the upper row on the display.
↓ ∇ or \triangle Key	
UNIT 1	The default number of Power Sensor/Monitor units appears at the lower row. Press the SET/REC/STOP key.
↓ SET/REC/STOP Key	
UNIT 1 ↑ Blinking	The numeral at the lower row starts blinking. Press the ∇ or \triangle key to set "5".
↓ ∇ or \triangle Key	
UNIT 5 ↑ Blinking	"5" is applied to NODE by pressing the SET/REC/STOP key. Once applied, the blinking at the lower row stops.
↓ SET/REC/STOP Key	
UNIT 5	

After the value is applied, the unit restarts when FUN mode is switched to THR mode.

3.6 Connecting to a Network

Network settings are required on the Power Sensor Stations to be connected to a network. Connect the LAN cables after completing the network settings on the station units.

Important

- A full understanding of LAN is required to connect stations to a network.
- Establish a dedicated LAN for connecting the Power Sensor Stations to a network.
- When the Power Sensor Station is connected to an in-house network or LAN Connection to an in-house network or LAN that has been already operated, the number of available IP addresses may be limited and there may be some rules to apply. Contact your network administrator. In such a case, OMRON does not guarantee the performance of the Power Sensor Stations and the PC software.

3.6.1 Preparation

Define the IP addresses and subnet masks to use before establishing a network connection.

Setting Example

Power Sensor Station IP Address	(Unit 1): 192.168.0.20 (Factory default) (Unit 2): 192.168.0.21
PC IP Address	192.168.0.100
Subnet Mask	255.255.255.0 (Factory default)

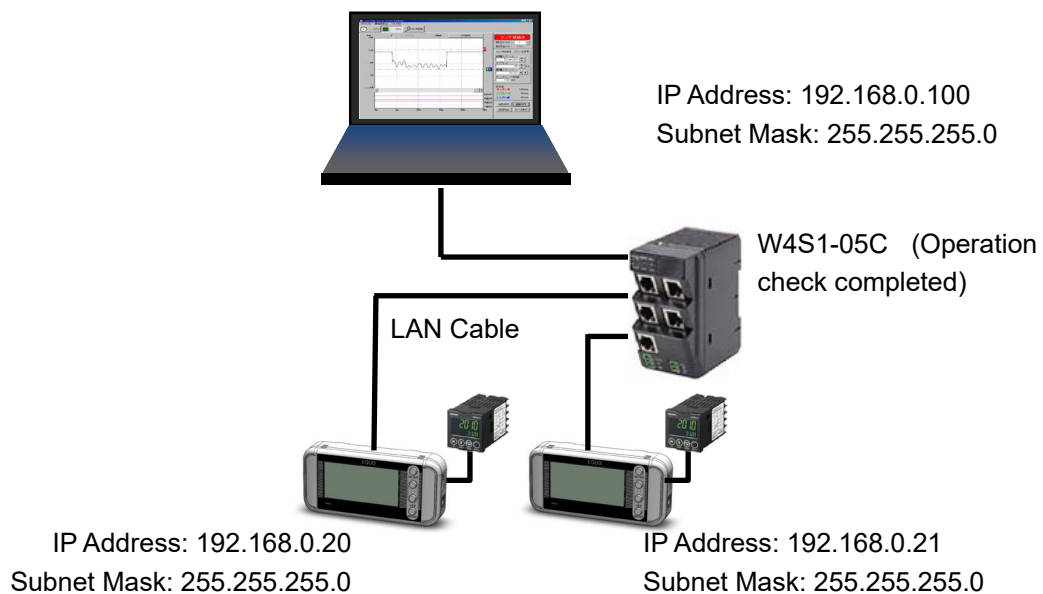

Note

- Power Sensor Stations are assigned by the IP address: 192.168.0.20, and subnet mask: 255.255.255.0 as the factory defaults.
- The IP addresses of the Power Sensor Stations and the PC must be individually unique and must not overlap one another in the network. In the example above, Power Sensor Station Unit 2 is assigned with "192.168.0.21", the PC, "192.168.0.100", changing the fourth value (segment) of the IP address of the station Unit 1, for distinguishing among the units connected.

- Set the same subnet mask value to both the Power Sensor Stations and PC to be connected in the network.
- To change the subnet mask, contact your network administrator. Even if the subnet mask is changed, the fourth segment of the IP addresses of the Power Sensor Stations and PC in the network must be distinguished from one another.
- The setting range of the individual segments of IP address and subnet mask is 0 to 255.

3.6.2 Setting Power Sensor Station IP Address

This section explains the procedure to set the IP address for Power Sensor Station Unit 2 (Example: Change the factory default "192.168.0.20" to "192.168.0.21").

Note

Refer to the sections below for details on messages displayed on the display unit and operational key functions.

Refer to: 2.1 Display Unit and 2.2 Control Unit

(1) Switching to "FUN" Mode

To change the IP address, press the MODE key until the "FUN" indicator at the right of the display starts blinking.

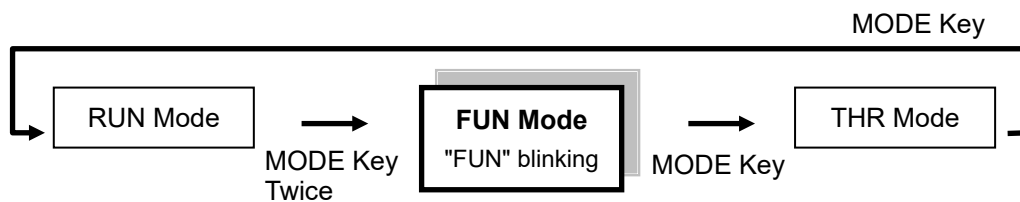

(2) Setting ETC and IP to "DISP"

Display (Upper/Lower)	Operation
CYCLE 10s ("FUN" Blinking)	Press the ▽ or △ key until "ETC" appears at the upper row on the display.
↓ ▽ or △ Key	
ETC OFF	Press the SET/REC/STOP key. "OFF" at the lower row starts blinking.
↓ SET/REC/STOP Key	
ETC OFF ↑ Blinking	Press the ▽△ keys to display "DISP".
↓ ▽ or △ Key	
ETC DISP ↑ Blinking	Press the SET/REC/STOP key to fix "DISP". Blinking stops.
↓ SET/REC/STOP Key	
ETC DISP	Press the ▽ or △ key to display "IP" at the upper row.
↓ ▽ or △ Key	
IP OFF	Press the SET/REC/STOP key. "OFF" at the lower row starts blinking.
↓ SET/REC/STOP Key	
IP OFF ↑ Blinking	Press the ▽ or △ key to display "DISP".
↓ ▽ or △ Key	
IP DISP ↑ Blinking	Press the SET/REC/STOP key to apply "DISP". Blinking stops.
↓ SET/REC/STOP Key	
IP DISP	Proceed to the IP address setting procedure.

(3) Changing IP Address (from factory default: 192.168.0.20 to 192.168.0.21)

Display (Upper/Lower)	Operation
IP DISP	Display the first segment of the IP address. Press the ∇ or Δ key until "P 1" appears at the upper row.

↓ ∇ or Δ Key

IP 1 192	Check that "192" is displayed at the lower row, and press the ∇ key. If "192" is not displayed, change the value referring to the changing "IP 4" example shown later.
-------------	--

↓ ∇ Key

IP 2 168	Check that "168" is displayed at the lower row, and press the ∇ key. If "168" is not displayed, change the value referring to the changing "IP 4" example shown below.
-------------	--

↓ ∇ Key

IP 3 0	Check that "0" is displayed at the lower row, and press the ∇ key. If "0" is not displayed, change the value referring to the changing "IP 4" example shown below.
-----------	--

↓ ∇ Key

IP 4 20	Press the SET/REC/STOP key to change the value displayed at the lower row to "21".
------------	--

↓ SET/REC/STOP Key

IP 4 020 ↑ Blinking	The value starts blinking. Press the ∇ or Δ key to change the value to "21".
---------------------------	--

↓ ∇ or Δ Key

IP 4 021 ↑ Blinking	Press the SET/REC/STOP key to apply the value. Blinking stops.
---------------------------	--

↓ SET/REC/STOP Key

IP 4 21	To check or change the subnet mask, press the ∇ key to display "SUB1" at the upper row.
------------	--

↓ ∇ Key

Check that SUB1 to SUB4 are set to 255, 255, 255 and 0 respectively and fix them in the same way as the procedure above.

After the settings for IP 1 to IP 4 and SUB1 to SUB4 are completed, press the MODE key.

"RESET" will be displayed and the unit resets itself.

3.6.3 Setting the PC IP Address

This section describes the procedure to change the IP address of the PC to "192.168.0.100".

Login with a user account with administrator/manager authority, which is required to change the IP address of the PC.

(1) Windows XP

Follow the procedure below to set the IP address.

- (1) Select "Start menu" – "Setup" – "Control Panel" to display the Control Panel and click "Network and Internet Connections".

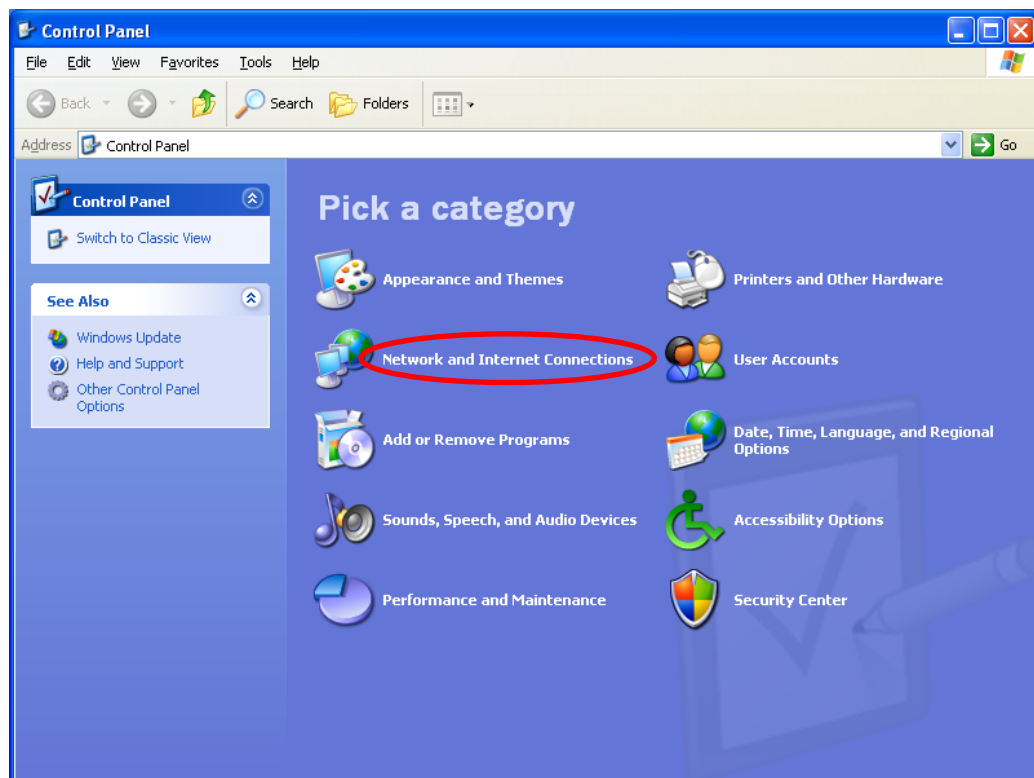

(2) Click "Network Connections".

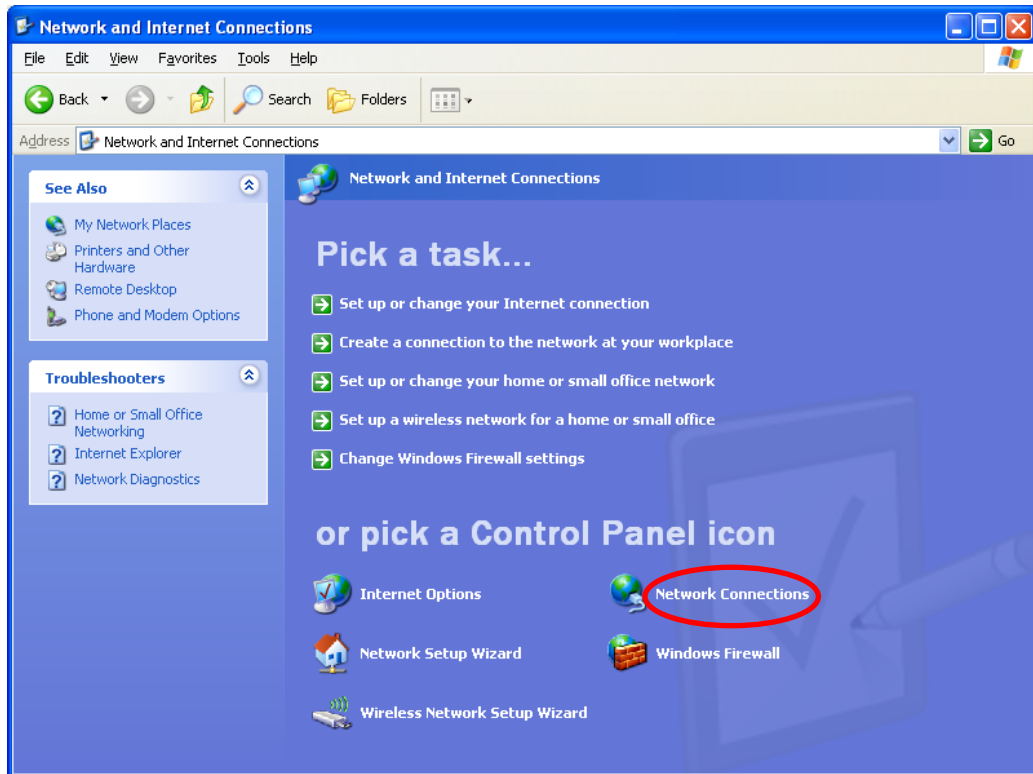

(3) Right-click "Local Area Connection" and select "Properties".

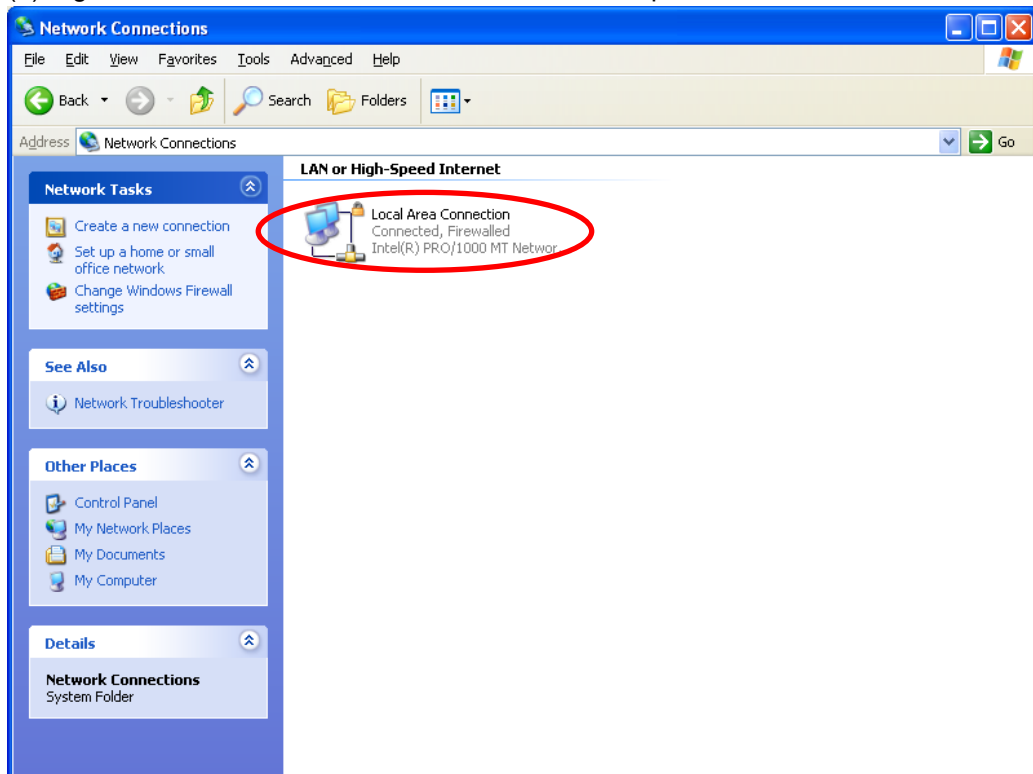

(4) Highlight "Internet Protocol (TCP/IP)" and click "Properties".

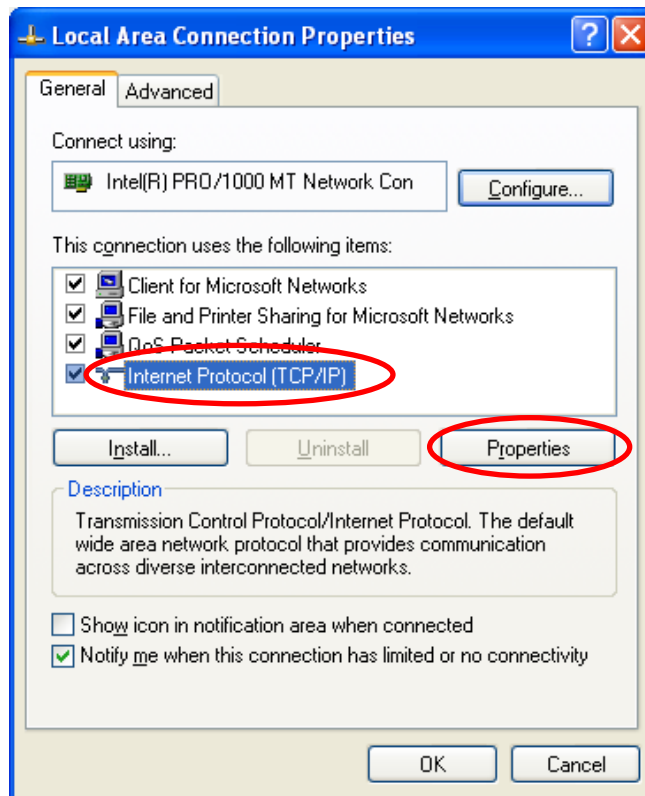

(5) Select "Use the following IP address" and set "IP address" to "192.168.0.100" and "Subnet mask" to "255.255.255.0". Press "OK" to close the window.

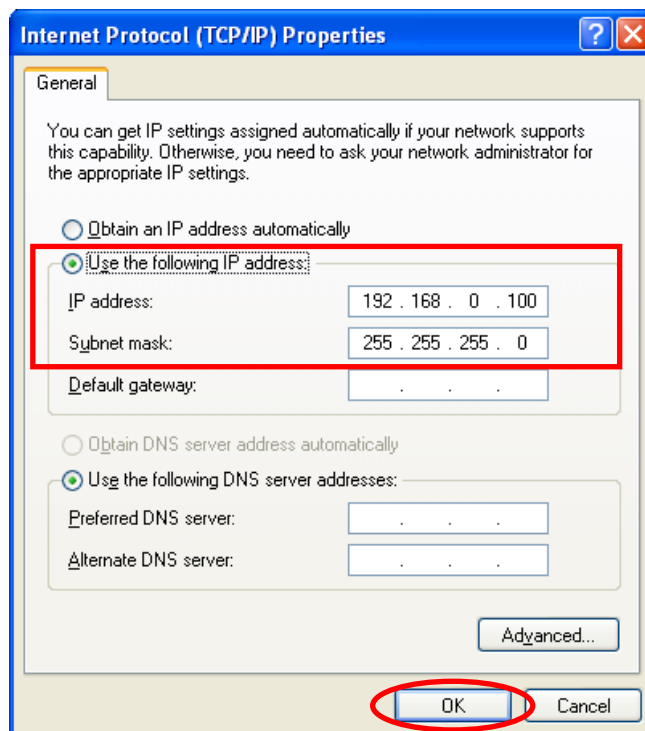

(6) Click "OK" in the "Local Area Connection Properties" window. The window closes.

(2) Windows Vista

Follow the procedure below to set the IP address.

(1) Select “Start menu” – “Control Panel” and click “Network and Internet”.

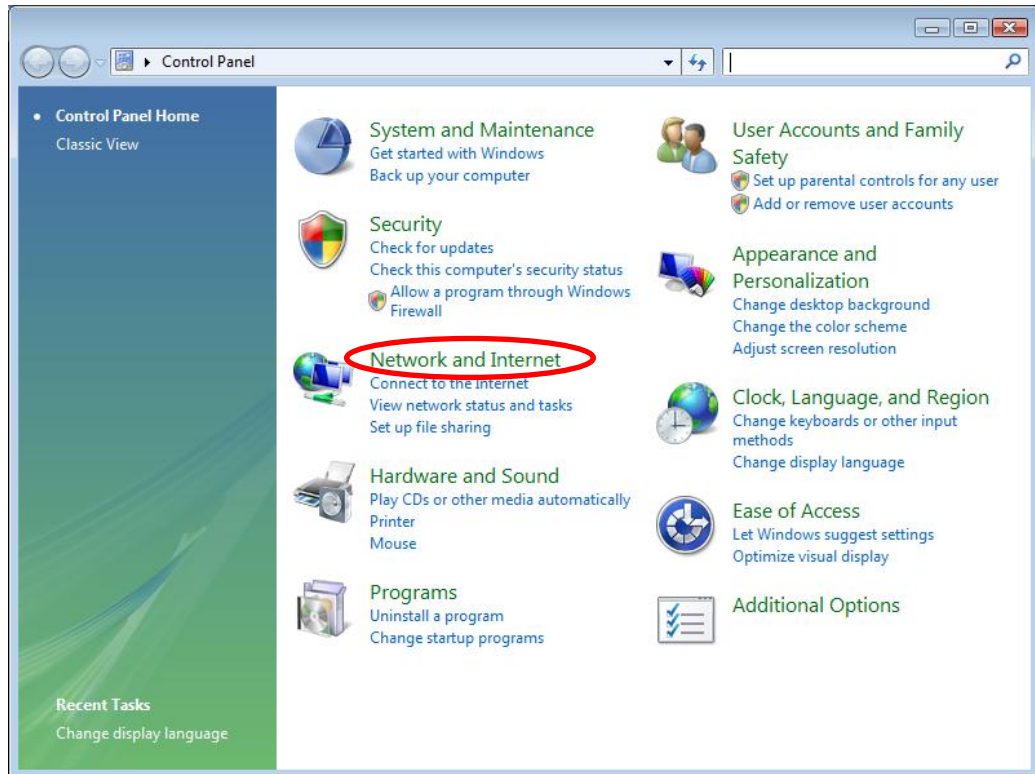

(2) Click “Network and Sharing Center”.

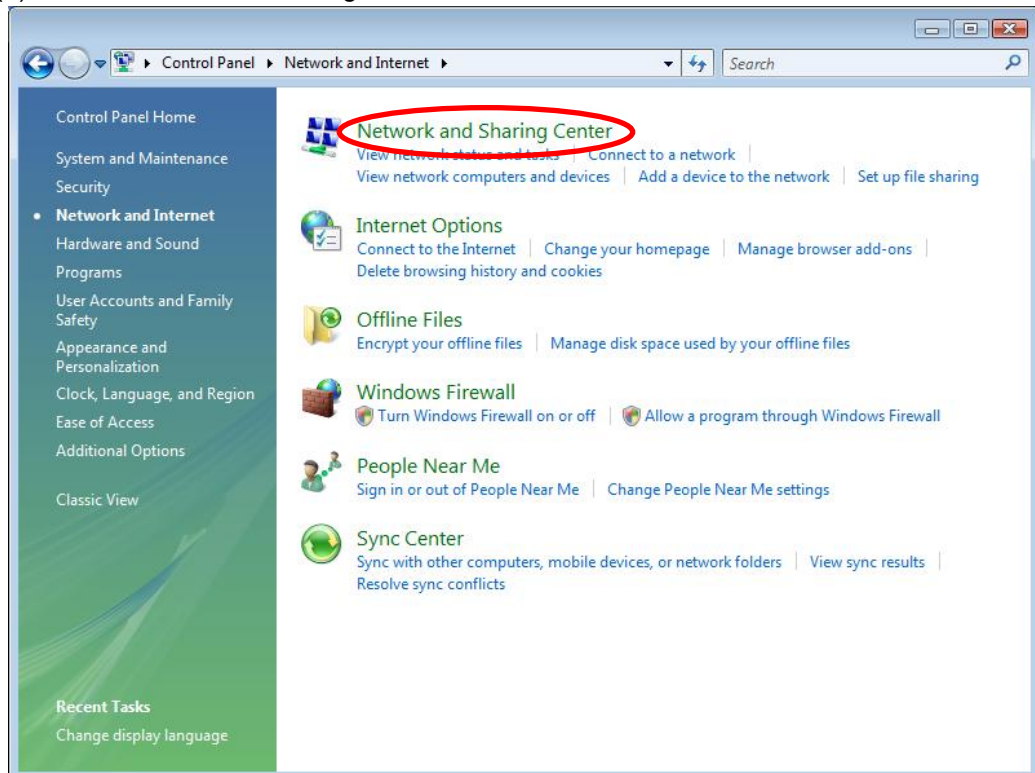

(3) Click "Manage network connections".

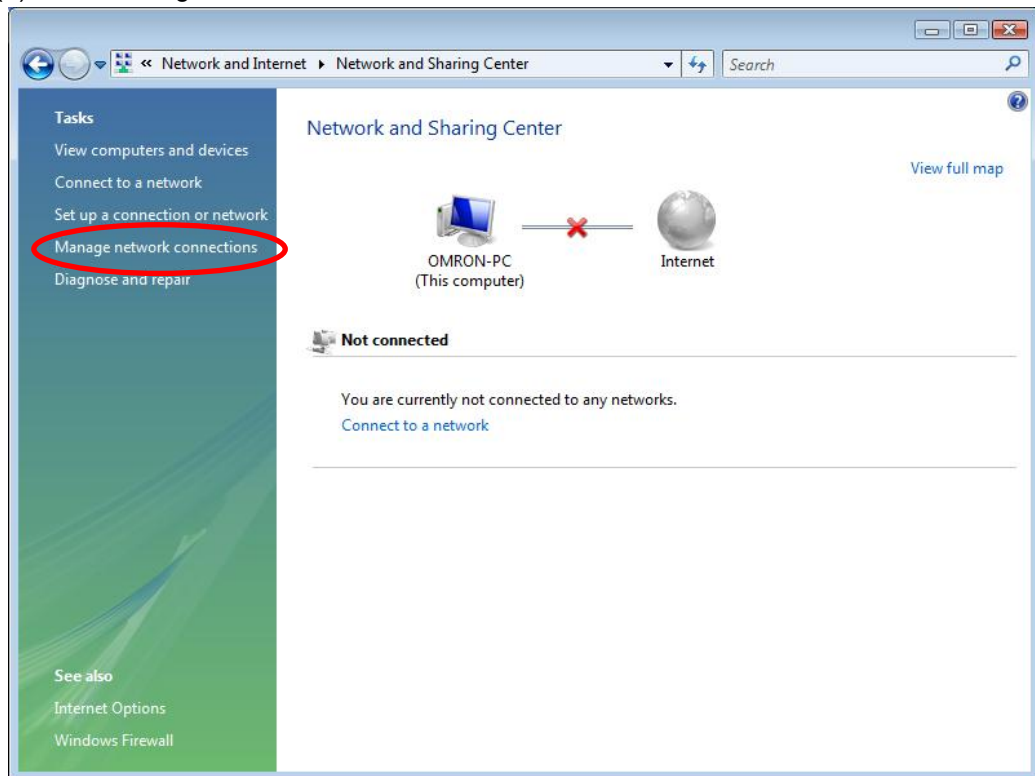

(4) Right-click "Local Area Connection" and select "Properties".

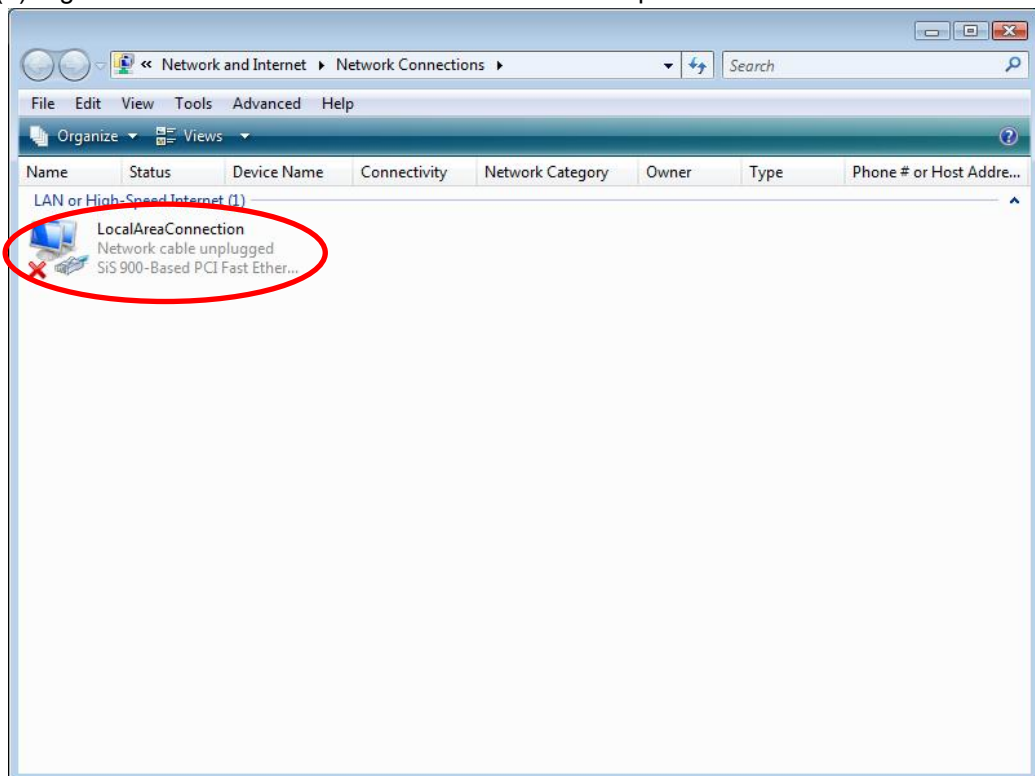

(5) When the "User Account Control" window appears, click "Continue".

(6) Select “Internet Protocol Version 4 (TCP/IPv4)” and click “Properties”.

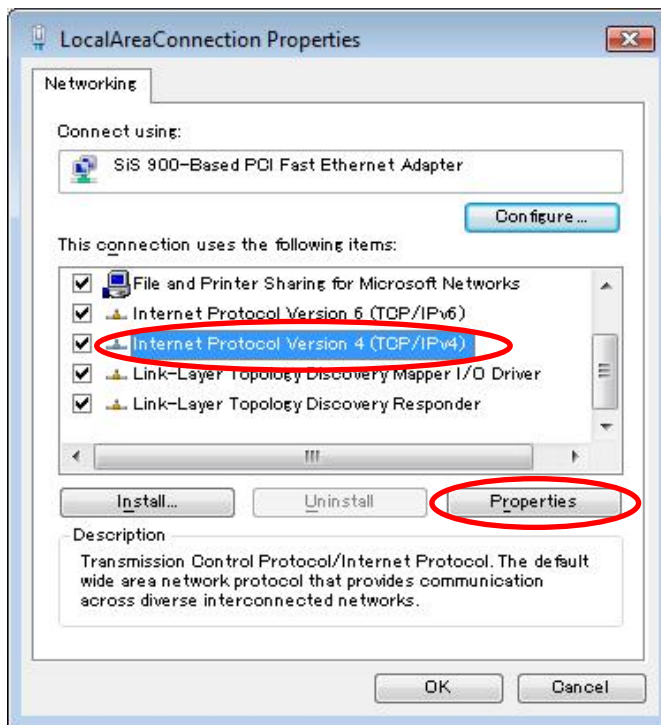

(7) Select “Use the following IP address” and set “IP address” and “Subnet mask”. Click “OK” to close the window.

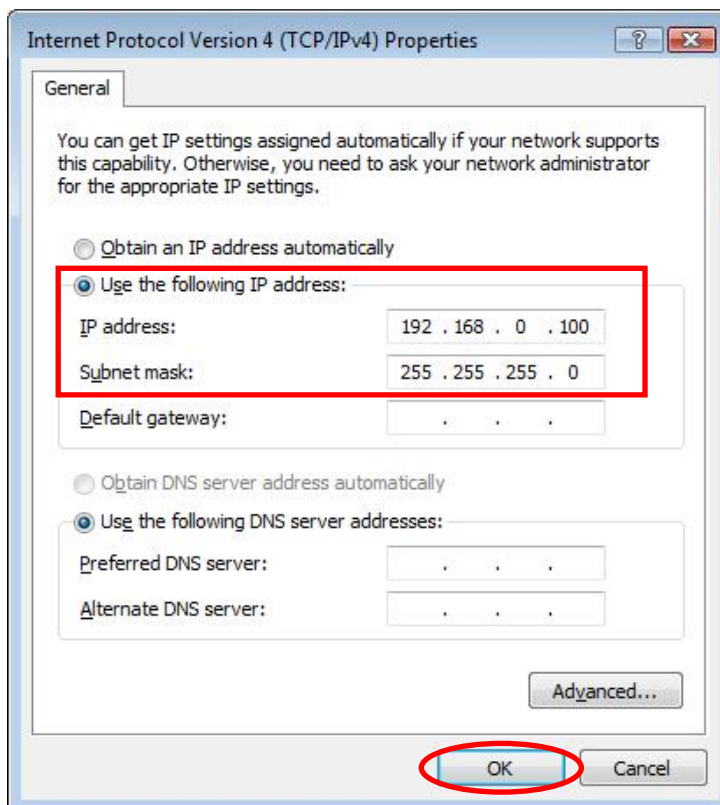

(8) Click "Close" in the “Local Area Connections Properties” window. The window closes.

(3) Windows 7

Follow the procedure below to set the IP address.

(1) Select “Start menu” – “Control Panel” and click “Network and Internet”.

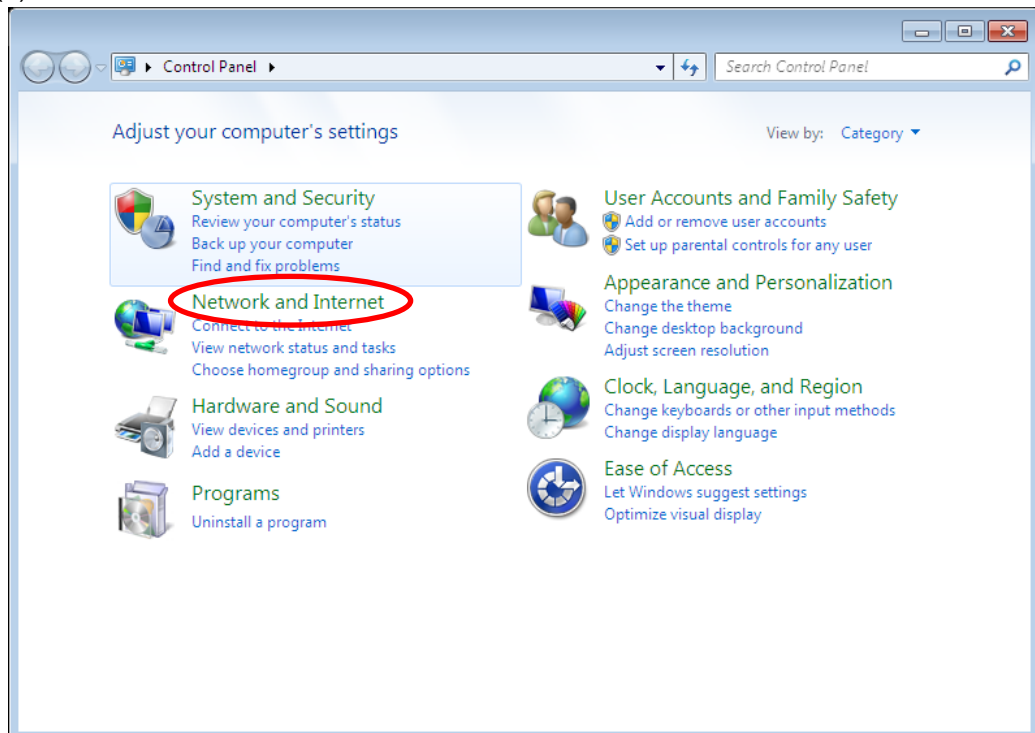

(2) Click “Network and Sharing Center”.

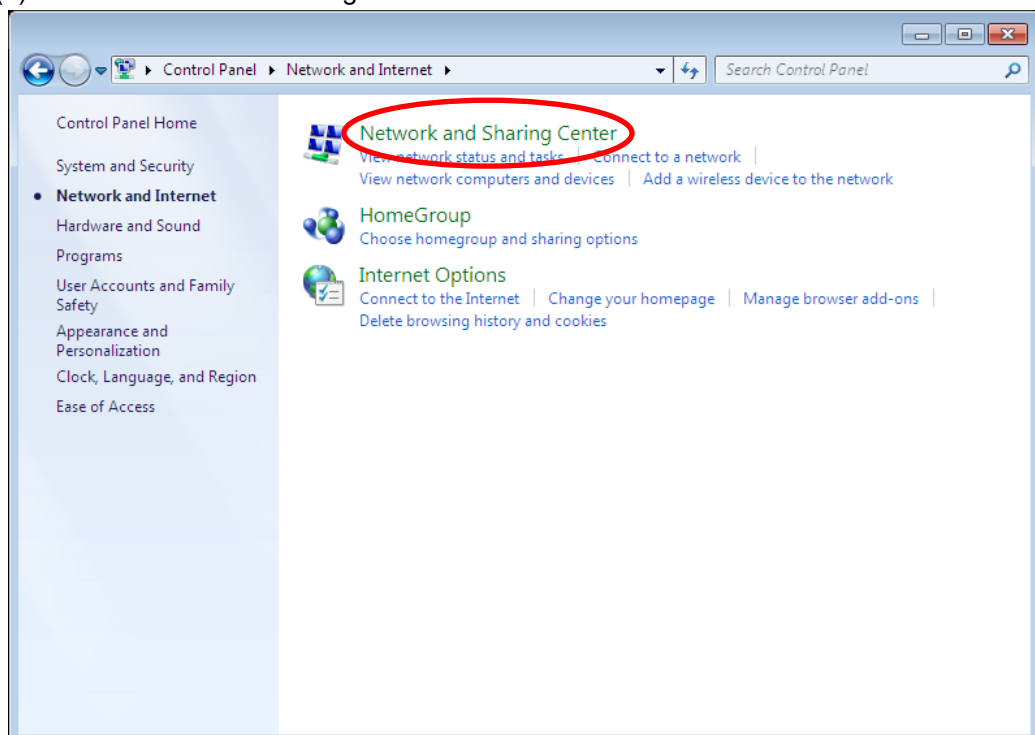

(3) Click “Change adapter settings”.

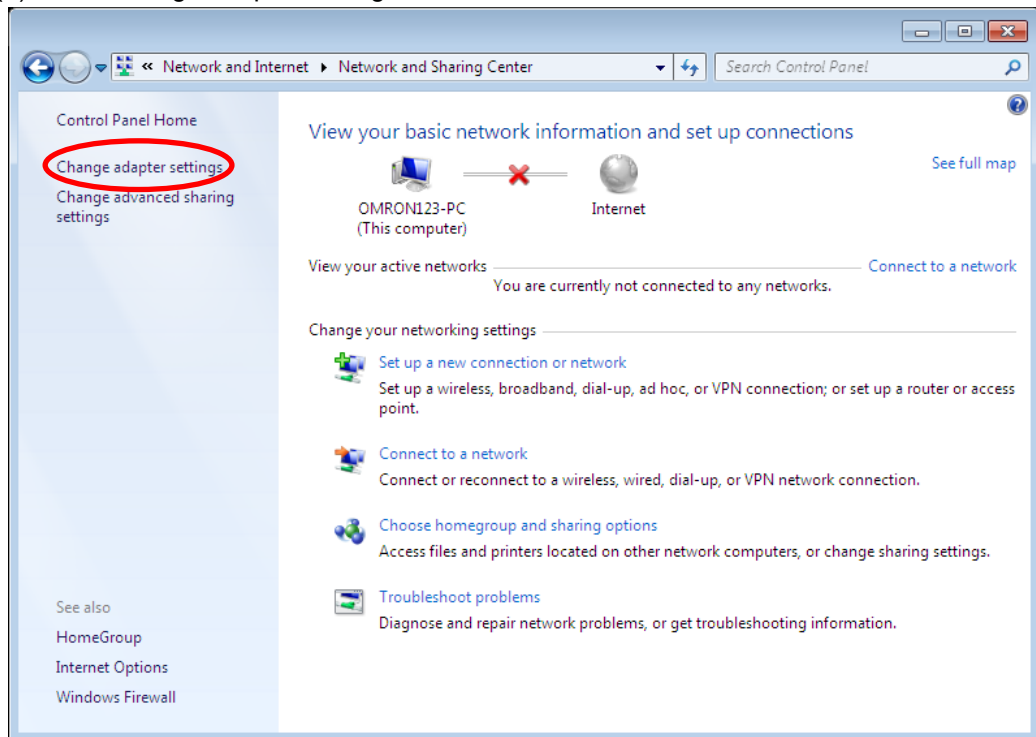

(4) Right-click “Local Area Connection” and select “Properties”.

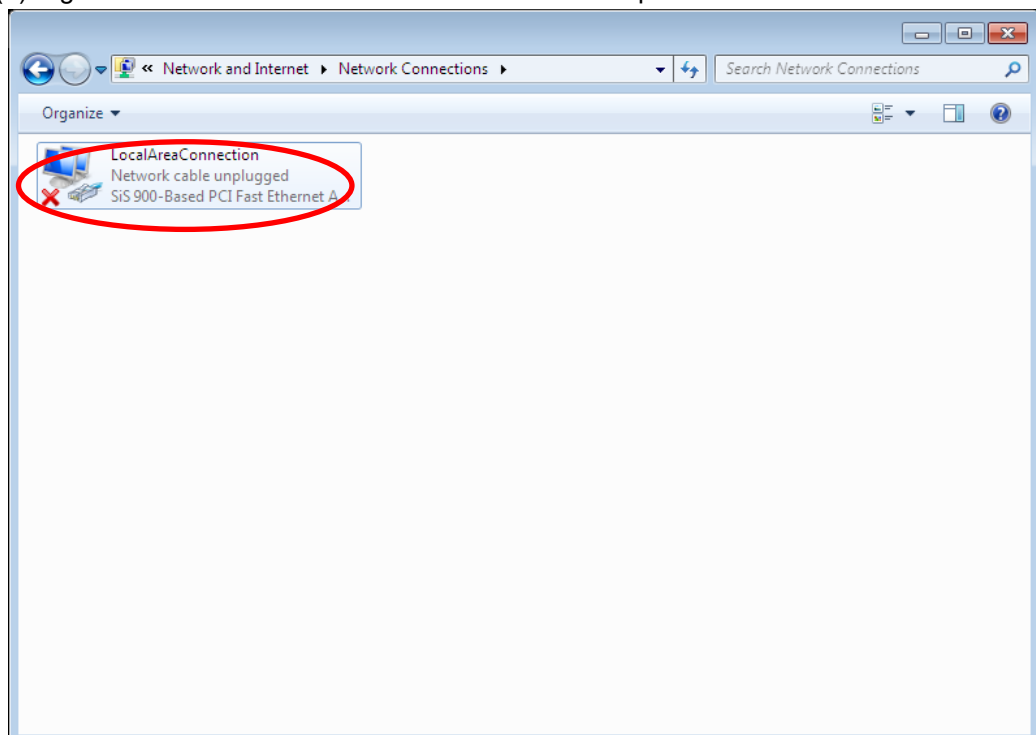

(5) Select “Internet Protocol Version 4 (TCP/IPv4)” and click “Properties”.

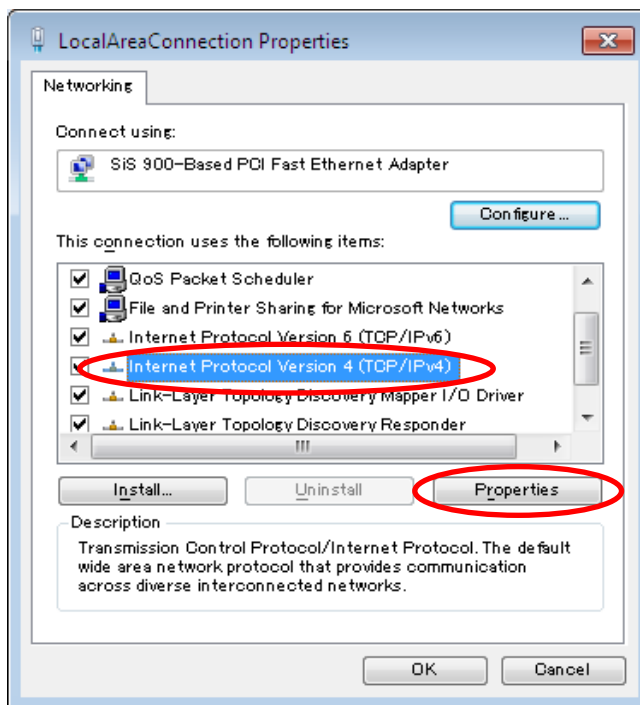

(6) Select “Use the following IP address” and set “IP address” and “Subnet mask”. Click “OK” to close the window.

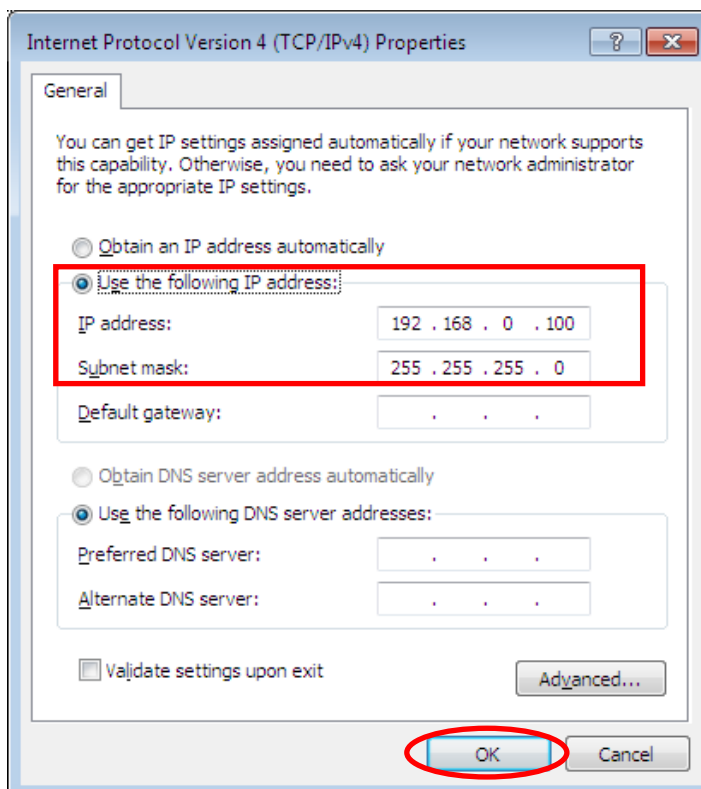

(7) Click "Close" in the “Local Area Connections Properties” window. The window closes.

3.6.4 Connecting a LAN Cable

Connect a LAN cable to the Power Sensor Station units and PC.

When the LAN cables is connected properly, "LAN" appears on the display.

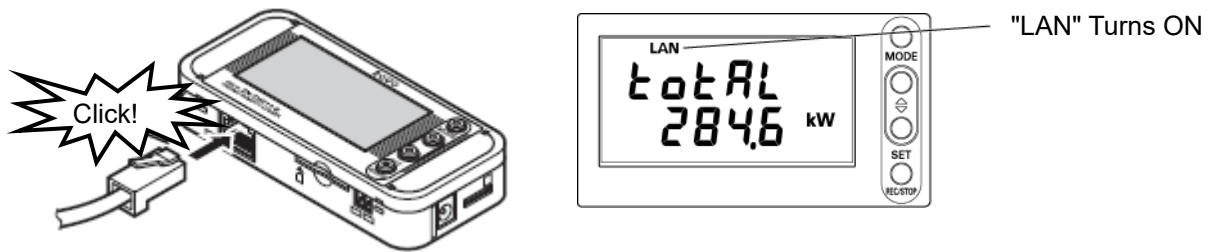

3.7 Installing the Unit

This section describes how to install a Power Sensor Station unit.

Important

This product is precision equipment. Be careful not to drop the unit.

Use the mounting screw holes for installation on the wall on other equipment or the place where vibration or shock may directly affect the unit.

3.7.1 Free-stand Installation

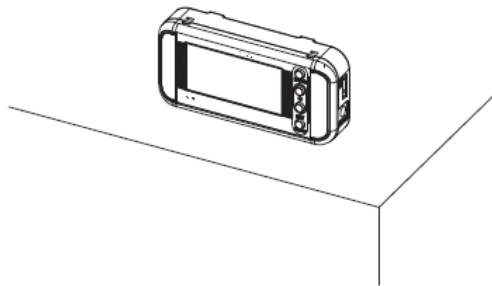

Important

When placing the product on a desk or place it with a sufficient distance from the edges or corners of the object to prevent damage from dropping. Be careful of handling the power supply cable, Power Sensor Station cables and LAN cable.

3.7.2 Securing with Mounting Screws

There are mounting screw holes on the back of the unit to secure the unit on the wall or other vertical surface. The unit can be secured with round magnets to the screw holes. (Refer to the Appendix: Installation Diagram for the hole dimensions.)

Flat-head Screws: M3 x 6

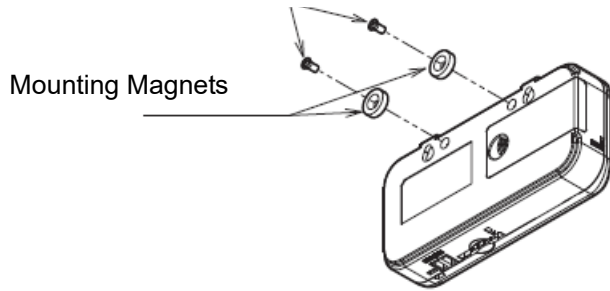

Important

The screw holes are 4 mm deep. Do not use screws longer than 4 mm. It may damage the product.

Note

The unit can be magnetically secured by ZN9-WM01-S magnets (sold separately). (Tightening torque: 0.4 N/cm to 0.6 N/cm)

Place the unit on a location where mechanical shock is not applied when mounting the magnets.

Be careful not to apply any load to the sensor head or cables.

Flat-head Screws: M3 x 6

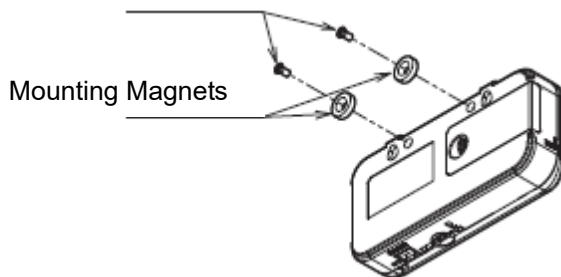

3.7.3 Mounting with Screw Hook Holes

There are two hook holes below the convex section of the upper unit for the product to be secured on the wall. (Refer to the Appendix: Installation Diagram for the screw hooking hole dimensions.)

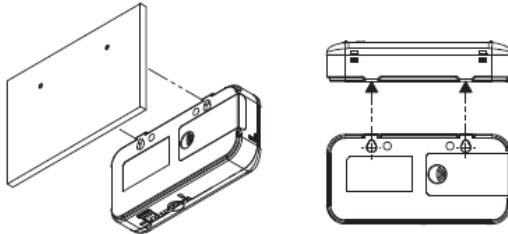

M3 screws to hook the screw head on the screw hook holes. Attach the device with an interval of 2.5 mm or more between the bottom of the screw head and the wall surface.

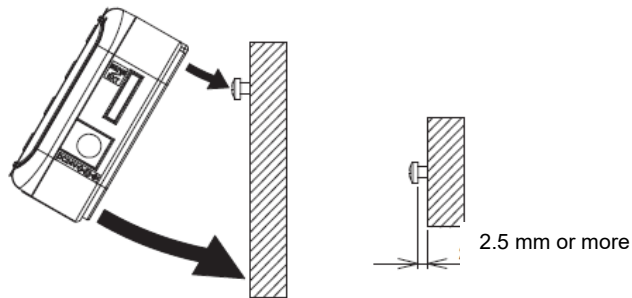

Enlarged Hook Screw Section View

Important

Firmly hold the unit with your hands to insert or remove the SD memory card when the unit is mounted by hooking. It may result in dropping and damaging SD memory card.

3.8 Power Sensor/Monitor Remote Setting (KM Series)

Remote settings of Power Sensors/Monitors from the PC via LAN are possible using the EasyKM-Manager PC software.

Preparation Required for Remote Setting:

- (1) Connection of the Power Sensors/Monitors (KM series) to the Power Sensor Station
(Refer to 3.3.1 KM Series Power Sensor/Monitor Settings)
- (2) Connection of the Power Sensor Station to the PC via network
(Refer to 3.6 Connecting to Network)

EasyKM-Manager Installation:

Download the EasyKM Manager software and instruction manual from the website below:

Download requires the registration as an I-Web member.

www.fa.omron.co.jp

EasyKM-Manager Setting:

Make necessary settings on the software for Power Sensors/Monitors (KM series) remote settings.

Start EasyKM-Manager and make the following communication settings.

Network Type	Select "Ethernet".
Protocol	Select either of [CompoWay/F] or [Modbus].
Communication Interval	Select the communication interval.
Ethernet Setting	PC side: IP Address Power Sensor/Monitor (KM Series) side: Unit Name, IP Address, Port No.

Refer to the EasyKM-Manager instruction manual for details.

Important

The Power Sensor Station functions as an Ethernet/RS-485 converter. Therefore, a command to change mode needs to be sent to the Power Sensor Station using the setting tool of the Station Utility. Set the network type in the EasyKM-Manager communication settings to "Ethernet". If it is set to "RS-232C", the communications with the Power Sensors/Monitors are not possible.

4. Setting the Unit (Unit Operation)

4.1 Setting Procedure and Operation Modes

The following diagram shows the Power Sensor Station setting procedure flow:

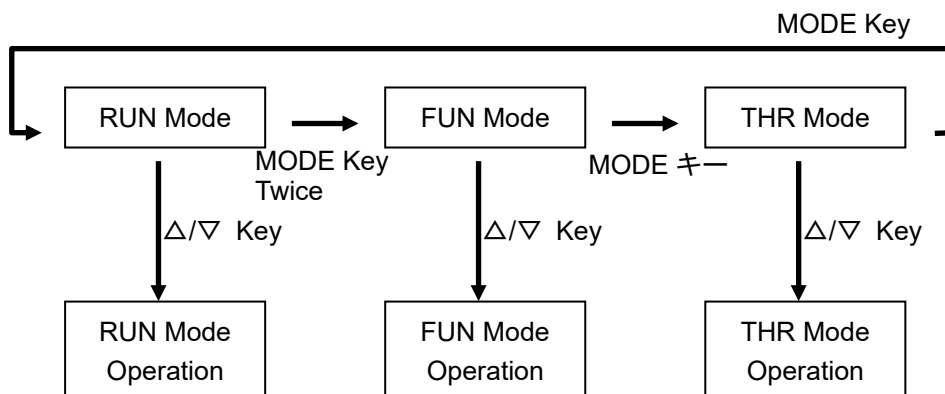

The Power Sensor Station provides the three operation modes, which can be switched with the MODE key.

To change the mode from RUN to FUN, press the MODE key twice. When pressing the MODE key once, "RUN" blinks. When pressing it twice, "FUN" blinks and the mode will be switched.

Use the Δ and ∇ keys to change and display items in each operation mode.

Table: Operation Mode

Display	Name	Description
"RUN" ON	Measurement Execution Mode (RUN Mode)	Used for power measurement and recording.
"FUN" Blinking	Function Setting Mode (FUN Mode)	Entered to make measurement and recording settings.
"THR" Blinking	Threshold Setting Mode (THR Mode)	Entered to make setting on the upper threshold limit for power alarm output.

Note

The mode cannot be changed during data recording in the internal memory in RUN mode ("REC" is displayed)

4.2 Settings in FUN Mode

Enter FUN mode to make measurement and recording settings on the Power Sensor Station.

4.2.1 List of Setting Items

The following list shows the setting items available in FUN mode.

Display Item		Display	Setting Item	Setting Value	Factory Default
CYCLE		<i>cYcLE</i>	Recording interval	1s (sec.)/2s/5s/10s/20s/30s/1m (min.)	10 s
UNIT		<i>Un it</i>	Number of Power Sensors/ Monitors connected	1 to 31	1
REC		<i>rEc</i>	Recording mode	CONT/RING	CONT
INTEG		<i>intEG</i>	Integrated power reset interval	OFF/30m (min.)/1h (hrs.)/24h "30m": Integrated power is reset to zero at 0 and 30 min. of every hour; "1h": reset at 0 min. of every hour; "24h": reset at 0:00 every day.	OFF
INIT		<i>in it</i>	Restore the factory default	Initialization starts at a long press of the SET/REC/STOP key. The unit restarts when the operation mode is changed after the "DONE" indication appears.	-
ETC (DISP)	RESTR	<i>rESTr</i>	Read setting data from the SD memory card.	The unit reads the setting data from a pre-inserted SD memory card to set itself, at a long press of the SET/REC/STOP key. The unit restarts when the operation mode is changed after the "DONE" indication appears.	-
	BCKUP	<i>bCkUP</i>	Write setting data to the SD memory card.	The unit saves the setting data in a pre-inserted SD memory card, at a long press of the SET/REC/STOP key.	-
CLOCK (DISP)	YEAR	<i>YEAr</i>	Year	Year setting	Not initialized by INIT.
	MONTH	<i>mOnth</i>	Month	Month setting	
	DAY	<i>dAY</i>	Day	Day setting	
	TIME	<i>tImE</i>	Hour/Minute	Hour/minute setting	

IP (DISP)	IP1 to IP4	<i>IP</i>	IP address	0 to 255	192. 168. 0. 20
	SUB1 to SUB4	<i>SUB</i>	Subnet mask	0 to 255	255. 255. 255. 0
RATE		<i>RATE</i>	Rate/CO ₂ conversion value setting	0.000 to 99.999	0
CONV		<i>CONV</i>	Conversion unit	JPY/USD/EUR/CNY/ KRW/CO ₂	JPY
UTOFS		<i>UTOFS</i>	Offset Unit No.	1 to 99	1
REREC		<i>REREC</i>	REC restoration availability at startup.	OFF/ON	OFF

4.2.2 Selecting "FUN" Operation Mode

Press the MODE key to change the operation mode to "FUN". "FUN" at the lower right of the display starts blinking.

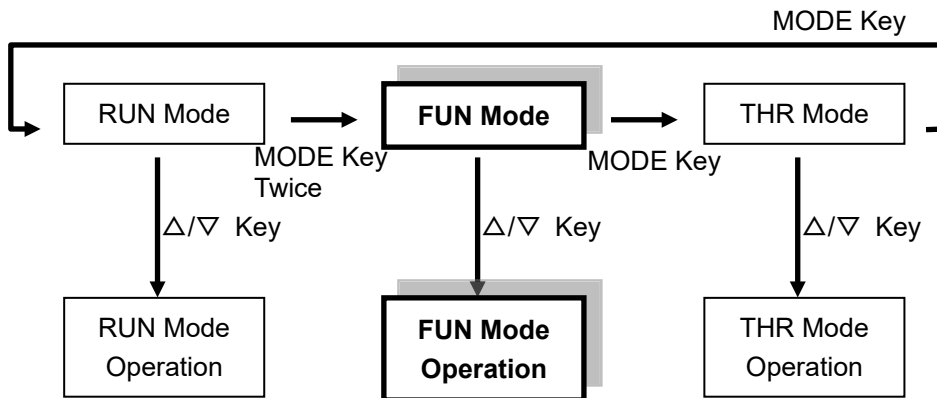

Note

While the data is being recorded in the internal memory, the mode cannot be changed to FUN mode.

4.2.3 Selecting Items

Move the selection items using the Δ and ∇ keys. To change the set value, select the item with the Δ or ∇ key and fix it with the SET/REC/STOP key. Press the MODE key to change the operation mode.

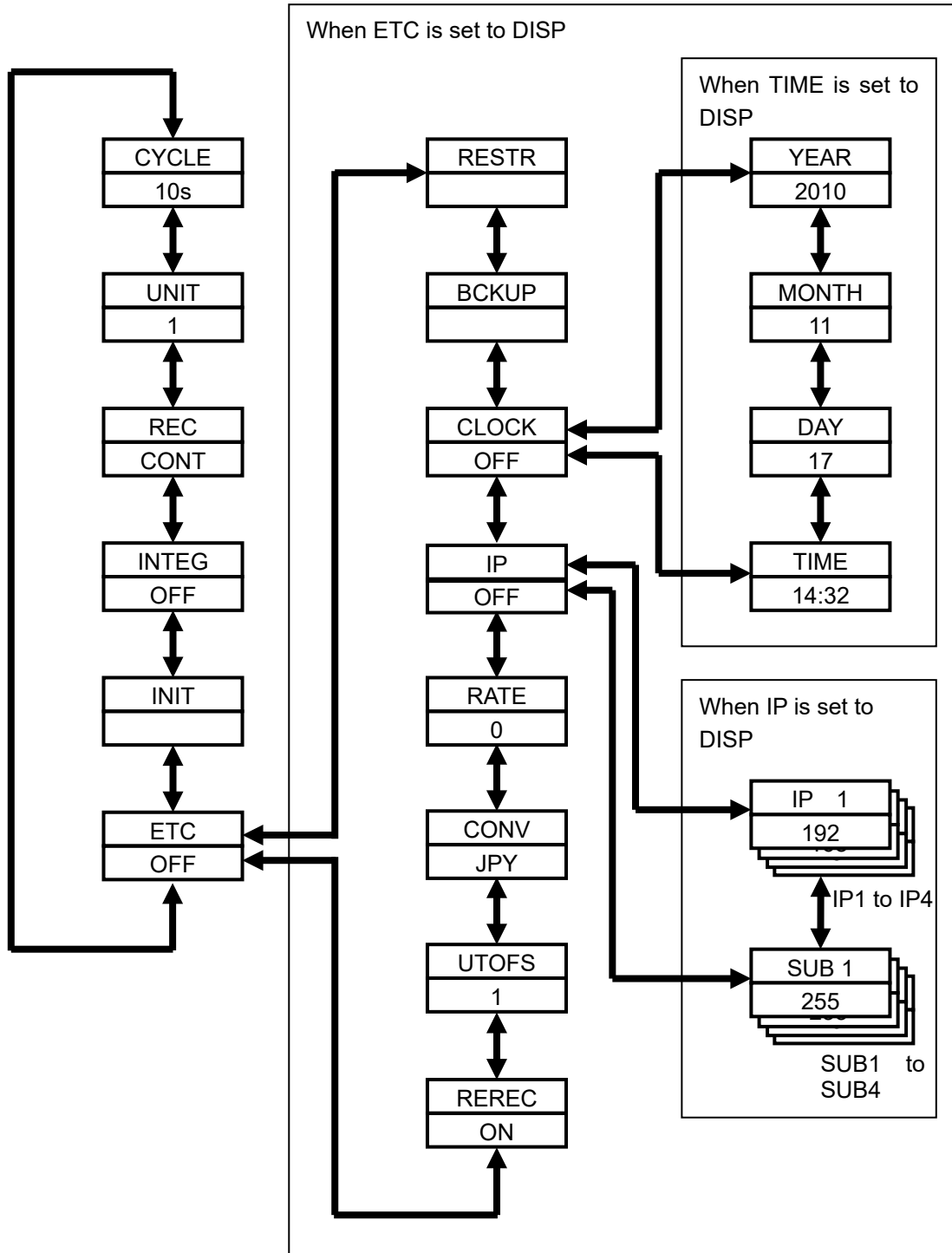

4.2.4 Description of Items

(1) Recording Interval (CYCLE)

Specifies the interval of measured value recording.

The range of selection (Options):

1s (second)/ 2s / 5s / 10s / 20s / 30s / 1m (minute)

Initial value: 10s

Important

■ Recording Interval and the Number of Connectable Units

The number of connectable Power Sensors/Monitors is restricted depending on the recording interval setting. Refer to the following table and specify the interval time. Only selectable items are displayed as the menu depending on the number of units connected.

Possible Interval Options for the Number of Units

Number of Units	Possible Interval Options
1 unit	1s / 2s / 5s / 10s / 20s / 30s / 1m
2 units	2s / 5s / 10s / 20s / 30s / 1m
3 to 6 units	5s / 10s / 20s / 30s / 1m
7 to 12 units	10s / 20s / 30s / 1m
13 to 24 units	20s / 30s / 1m
25 to 31 units	30s / 1m

Possible Number of Units for Interval Options (UNIT)

Recording Interval	Possible Number of Units (UNIT)
1 second	1 unit
2 seconds	Up to 2 units
5 seconds	Up to 6 units
10 seconds	Up to 12 units
20 seconds	Up to 24 units
30 seconds	Up to 31 units
1 minute	Up to 31 units

Note**■Recording Interval and Internal Memory**

The possible recording time in the internal memory varies depending on the recording interval setting. The details are shown in the table below.

The recording time also differs depending on the types of Power Sensors/Monitors to be connected.

(1) When KM20-B40-FLK/KM100 are connected:

Recording Interval	Possible Internal Memory Recording Time			
	1 Unit Connected	5 Units Connected	10 Units Connected	31 Units Connected
1 second	Approx. 1 hr. 50 min.	-	-	-
2 seconds	Approx. 3 hr. 40 min.	-	-	-
5 seconds	Approx. 9 hr. 30 min.	Approx. 2 hr. 40 min.	-	-
10 seconds	Approx. 19 hr.	Approx. 5 hr. 20 min.	Approx. 2 hr. 50 min.	-
20 seconds	Approx. 1 day 14 hr.	Approx. 10 hr. 50 min.	Approx. 5 hr. 40 min.	-
30 seconds	Approx. 2 days	Approx. 8 hr. 30 min.	Approx. 8 hr. 30 min.	Approx. 2 hr. 50 min.
1 minute	Approx. 4 days	Approx. 17 hr. 10 min.	Approx. 17 hr. 10 min.	Approx. 5 hr. 40 min.

(2) When KM50-C/KM50-E are connected:

Recording Interval	Possible Internal Memory Recording Time			
	1 Unit Connected	5 Units Connected	10 Units Connected	31 Units Connected
1 second	Approx. 1 hr. 20 min.	-	-	-
2 seconds	Approx. 2 hr. 40 min.	-	-	-
5 seconds	Approx. 6 hr. 40 min.	Approx. 1 hr. 40 min.	-	-
10 seconds	Approx. 13 hr. 20 min.	Approx. 3 hr. 20 min.	Approx. 1 hr. 40 min.	-
20 seconds	Approx. 1 day 2 hr.	Approx. 6 hr. 40 min.	Approx. 3 hr. 30 min.	-
30 seconds	Approx. 1 day 16 hr.	Approx. 10 hr. 10 min.	Approx. 5 hr. 10 min.	Approx. 1 hr. 40 min.
1 minute	Approx. 3 days 8 hr.	Approx. 20 hr. 20 min.	Approx. 10 hr. 30 min.	Approx. 3 hr. 20 min.

(3) When KM-N1-FLK/KM-N2-FLK/KM-N3-FLK are connected:

Recording Interval	Possible Internal Memory Recording Time			
	1 Unit Connected	5 Units Connected	10 Units Connected	31 Units Connected
1 second	Approx. 1 hr. 50 min.	-	-	-
2 seconds	Approx. 3 hr. 40 min.	-	-	-
5 seconds	Approx. 9 hr. 30 min.	Approx. 2 hr. 40 min.	-	-

10 seconds	Approx. 19 hr.	Approx. 5 hr. 20 min.	Approx. 2 hr. 50 min.	-
20 seconds	Approx. 1 day 14 hr.	Approx. 10 hr. 50 min.	Approx. 5 hr. 40 min.	-
30 seconds	Approx. 2 days	Approx. 8 hr. 30 min.	Approx. 8 hr. 30 min.	Approx. 2 hr. 50 min.
1 minute	Approx. 4 days	Approx. 17 hr. 10 min.	Approx. 17 hr. 10 min.	Approx. 5 hr. 40 min.

Please note that the table above does not include the recording times when KM50-□ is combined with other types.

(2) Number of Power Sensor/Monitor Units Connected (UNIT)

Specifies the number of Power Sensor/Monitor units to be connected.

The range of selection (Numeric input):

1 to 31

Initial value: 1

Important

■ Recording Interval and the Number of Connectable Units

The recording interval setting (CYCLE) is restricted depending on the connectable number of Power Sensor/Monitor units. The CYCLE value automatically changes to the smallest possible interval, in case that the number of Power Sensor/Monitor units is increased and the previous interval value becomes irrelevant.

(3) Recording Mode (REC)

Specifies the writing operation to the SD memory card during recording.

The range of selection (Options):

CONT / RING

Initial value: CONT

Recording Mode	Operation
CONT	Continue mode The unit outputs the files in the internal memory to the SD memory card when the internal memory becomes full during recording, and continues recording. If an error occurs due to no insertion of an SD memory card, the unit stops recording and holds the data in the internal memory.
RING	Ring mode The unit overwrites the oldest data in the internal memory when the internal memory becomes full, and continues recording.

Note

- A press of the SET/REC/STOP key (for 3 seconds or less) during recording enables the unit to output the data accumulated so far in the internal memory to the SD memory card without stopping recording.

(4) Integrated Power Reset Interval (INTEG)

Specifies the interval for resetting the integrated power to be displayed. The integrated power of the internal memory is not reset.

The range of selection (Options):

OFF / 30m (min.) / 1h (hr.) / 24h

Initial value: OFF

Setting Value	Operation
OFF	The unit continuously measures the integrated power without resetting the value to zero.
30m	The unit measures the integrated value at the interval of 30 minutes; at 0 and 30 minutes of every hour (0:00 to 0:30; 0:30 to 1:00; 1:00 to 1:30...).
1h	The unit measures the integrated value at the interval of one hour; at 0 minutes of every hour (0:00, 1:00, 2:00...).
24h	The unit measures the integrated value at the interval of 24 hours; at 0:00 of every day.

(5) Initialization (INIT)

The unit initializes the setting values and restore the factory defaults (except for year, month, day, hour and minute settings).

Operation:

Initialization starts at a long press of the SET/REC/STOP key and is completed when "DONE" is displayed.

The unit resets itself and restarts when the MODE key is pressed to change the operation mode.

(6) Others (ETC)

Specifies if the unit displays the items for setting file read/write, time setting, IP address, rate/CO₂ conversion value setting and conversion unit setting.

Setting range:

OFF / DISP

Initial value: OFF

Setting Value	Operation
OFF	The unit does not display the items for setting file read/write, time setting, IP address, rate/CO ₂ conversion value setting and conversion unit setting. The CYCLE item returns when the ∇ key is pressed after the setting is applied with the SET/REC/STOP key.
DISP	The unit displays the items for setting file read/write, time setting, IP address, rate/CO ₂ conversion value setting and conversion unit setting. The RESTR item is displayed when the ∇ key is pressed after the setting is applied with the SET/REC/STOP key.

Note

The ETC setting returns to "OFF" when the unit is reset.

(7) Reading Setting Data (RESTR)

Restores the unit settings by using the SD memory card with the setting data saved as a backup using the BCKUP setting (described later).

Operation:

Insert the SD card containing the setting data, and hold the SET/REC/STOP key. Reading is completed when "DONE" is displayed.

The unit resets itself and restarts when the MODE key is pressed to change the operation mode.

Note

- Only one setting data item (the setting data for only one unit) can be stored in a single SD card as a backup. The setting data backed up in one Power Sensor Station can be restored on other Power Sensor Station unit.
- Setting data reading is not possible when ETC is set to "OFF".

(8) Writing the Setting Data (BCKUP)

Saves the unit setting data in an SD memory card as a backup.

Operation:

Insert an SD memory card and hold the SET/REC/STOP key.
Saving is complete when "DONE" is displayed.

Important

Only one setting data item (the setting data for only one unit) can be stored in a single SD card as a backup. If an SD card containing an already-saved setting data backup is used, the setting data in the card is overwritten. The same applies to a backup performed on other Power Sensor Station: the data is overwritten.

Note

- The setting data is written into the SYSTEM folder in the SD card.
- Setting data writing is not possible when ETC is set to "OFF".

(9) Setting Clock (CLOCK)

Specifies if the internal clock setting is required.

The range of selection (Options):

OFF / DISP

Initial value: OFF

Setting Value	Operation
OFF	Time setting is not available. The IP item is displayed when the ▽ key is pressed after the setting is applied with the SET/REC/STOP key.
DISP	Time setting is available. The YEAR item is displayed when the ▽ key is pressed after the setting is applied with the SET/REC/STOP key.

Note

- The CLOCK setting is not possible when ETC is set to "OFF".
- The CLOCK setting returns to "OFF" when the unit is reset.

(10) YEAR/MONTH/DAY/TIME Setting

Specifies the year/month/day/time values.

Setting range (Numeric input):

YEAR: 2000 to 2099

MONTH: 1 to 12

DAY: 1 to 31

TIME: 00:00 to 23:59

Note

The year/month/day/time settings are not possible when ETC is set to "OFF" and CLOCK?? is also set to "OFF".

(11) Setting IP Address (IP)

Specifies if the IP address setting is required.

The range of selection (Options):

OFF / DISP

Initial value: OFF

Setting Value	Operation
OFF	IP address settings are not available. The SDISP item is displayed when the ∇ key is pressed after the setting is applied with the SET/REC/STOP key.
DISP	IP address settings are available. The IP 1 item is displayed when the ∇ key is pressed after the setting is applied with the SET/REC/STOP key.

Note

- The IP setting is not possible when ETC is set to "OFF".
- The IP setting returns to "OFF" when the unit is reset.

(12) IP Address and Subnet Mask (IP 1 to IP 4, SUB 1 to SUB 4)

Specifies the 4 segments of the IP address (IP 1 to IP 4) and the 4 segments of the subnet mask (SUB 1 to SUB 4).

Setting range (Numeric input):

IP 1, IP 2, IP 3, IP 4: 0 to 255

SUB 1, SUB 2, SUB 3, SUB 4: 0 to 255

Initial value: IP 1.IP 2.IP 3.IP 4 = 192.168.0.20

SUB 1.SUB 2.SUB 3.SUB 4 = 255.255.255.0

Note

- The unit resets itself and restarts when the MODE key is pressed to change the operation mode, after the IP address and subnet mask values have been changed and applied with the SET/REC/STOP key.
- The IP address and subnet mask settings are not possible when ETC is set to "OFF" and IP is also set to "OFF".

(13) Rate/CO₂ Conversion Value Setting (RATE)

Specifies the electricity rate or CO₂ emission level per 1kWh.

Setting range (Numeric input):

0.000 to 99.999

Initial value: 0

Note

The rate/CO₂ conversion value setting is not possible when ETC is set to "OFF".

(14) Conversion Unit Setting (CONV)

Specifies the unit for the rate/CO₂ conversion setting (RATE).

The range of selection (Options):

JPY (Japanese yen) / USD (US dollar) / EUR (Euro) / CNY (Chinese yuan) / KRW (Korean won) /

CO₂ (CO₂ emission level per 1kWh)

Initial value: JPY

Note

The conversion unit setting is not possible when ETC is set to "OFF".

(15) Offset Unit No. (UTOFS)

Specifies the starting (offset) unit number set for the Power Sensor/Monitor units to be connected.

To use the unit numbers from No.10 to No.15, for example, "10" is set for the offset number (this setting item), while "6" is set for the number of Power Sensor/Monitor units to be connected (UNIT).

The range of selection (Numeric input):

1 to 99

Initial value: 1

Important

The unit numbers for UTOFS and UNIT settings must not exceed "99".

However, depending on the offset number setting and the number of connected Power Sensor/Monitor units, 100 or larger numbers may exist. In this case, the set value of the unit is automatically changed so that the maximum value of the unit number is 99.

(16) Power Failure REC Restoration (REREC)

Startup REC restoration refers to the feature that can automatically resume the REC operation at the restart after the power is turned OFF during recording. The unit can continue the recording of measured values without any further procedure by the operator.

This item is used to specify if this function is required.

The range of selection (Options??):

OFF / ON

Initial value: OFF

Setting Value	Operation
OFF	The unit does not use this function (No REC restoration).
ON	The unit uses this function (Auto REC restoration).

Important

The data remaining in the internal memory is output to the SD memory card at startup regardless of the setting.

Be careful that the remaining data in the internal memory is discarded and recording is resumed without an error indication.

4.2.5 Changing the Set Value

The value setting depends on the type of items, which are classified into option selection type and numeric input type.

(1) Changing Option Type Item Value (Example: CYCLE)

Press the MODE key several times to enter FUN mode, and press the ∇ or Δ key to display CYCLE.

Display (Upper/Lower)	Operation
CYCLE 10 s	Press the MODE key repeatedly until "FUN" starts blinking. Press the ∇ or Δ key to display CYCLE at the upper row of the display. Press the SET/REC/STOP key, then, the value at the lower row starts blinking.

SET/REC/STOP Key ↓

Display (Upper/Lower)	Operation
CYCLE 10 s ↑ Blinking	The value options are displayed in sequence by pressing the Δ or ∇ key. To cancel the setting attempt, press the MODE key.

∇ or Δ Key ↓

Display (Upper/Lower)	Operation
CYCLE 30 s ↑ Blinking	Press the Δ or ∇ key to display the desired value, and press the SET/REC/STOP key. The value is applied and the blinking stops.

SET/REC/STOP Key ↓

Display (Upper/Lower)	Operation
CYCLE 30 s	

Use the Δ or ∇ key again to display other setting item and MODE key to change the operation mode.

(2) Changing Numeric Input Type Item Value (Example: YEAR)

Press the MODE key several times to enter FUN mode, and press the ∇ or Δ key to display YEAR.

To display YEAR, ETC and TIME must have been set to DISP beforehand.

Display (Upper/Lower)	Operation
CYCLE 10s ("FUN" Blinking)	Press the MODE key repeatedly until "FUN" starts blinking. "CYCLE" is displayed at the upper row. Press the ∇ or Δ key to display YEAR. To display YEAR, ETC and TIME must be set to DISP.

∇ or Δ Key \downarrow

Display (Upper/Lower)	Operation
YEAR 2010	Press the SET/REC/STOP key, then, the last digit number at the lower row starts blinking.

SET/REC/STOP Key \downarrow

Display (Upper/Lower)	Operation
YEAR 2010 ↑ Blinking	The value increases or decreases at a press of the Δ or ∇ key. The amount of increase/decrease becomes larger by holding Δ or ∇ key. To cancel the setting attempt, press the MODE key.

∇ or Δ Key \downarrow

Display (Upper/Lower)	Operation
YEAR 2011 ↑ Blinking	Press the Δ or ∇ key to display the desired value, and press the SET/REC/STOP key. The value is applied and the blinking stops.

SET/REC/STOP Key \downarrow

Display (Upper/Lower)	Operation
YEAR 2011	

Use the Δ or ∇ key again to display other setting item and MODE key to change the operation mode.

4.3 Settings in THR Mode

THR mode must be entered for setting the threshold for Power Sensor Station alarm output.

Set the upper limit of the integrated power consumption for the threshold value.

If the measured value exceeds the set upper limit value during RUN operation, the station's alarm output terminal turns ON and the "ALM" indication on the display turns ON.

Note

Alarm monitoring cannot be stopped.

However, it can be avoided by setting the threshold value outside a possible measurement range or to "0". The factory default is set to a value in which alarm monitoring is not performed ("0" is set to the alarm upper limit value).

4.3.1 List of Setting Items

The table below shows the THR mode setting item list.

Display Item	Display	Setting Item	Function/Operation	Factory Default
INT H	int h	Integrated power upper limit threshold	Used to specify the integrated power consumption upper limit threshold for an alarm output.	0 kWh

The integrated power threshold is evaluated against a total sum of the power values acquired from the connected Power Sensor/Monitor units.

4.3.2 Selecting "THR" Operation Mode

Press the MODE key to change the operation mode to "THR". "THR" at the lower right of the display starts blinking.

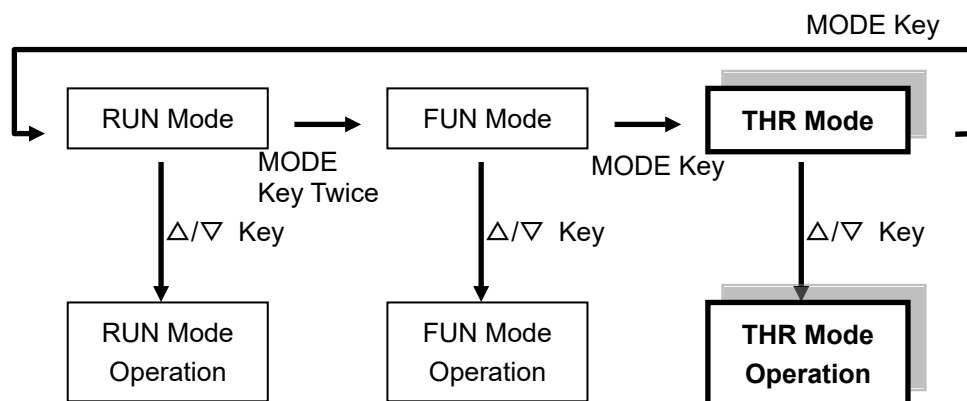

4.3.3 Selecting Items

To change the set value, select the item with Δ or ∇ key and apply the selection with the SET/REC/STOP key. Press the MODE key to change the operation mode.

INT H
0 kWh

4.3.4 Definition of Items

(1) Integrated Power Upper Limit Threshold (INT H)

Specifies the upper limit of the integrated power threshold for an alarm output.

The "ALM" indication and alarm output turn ON, when the measured integrated power exceeds the set value.

Setting range (Numeric input):

0 Wh to 99999 kWh (Threshold setting becomes "OFF" if "0" is specified)

Initial value:

0 kWh

4.3.5 Changing the Set Value

Follow the same procedure as in FUN mode.

Refer to: 4.2.5 Changing the Set Value

4.4 Copying Setting Data for Multiple Station Units

The settings on multiple Power Sensor Station units can be unified by using the same setting data saved in an SD memory card. By making necessary settings only on one unit (through unit operation and saving them in an SD memory card, you can restore the same settings in other units. This greatly saves the entire setting procedures, and minimizes setting errors. This is convenient especially when controlling multiple units using the same settings.

Refer to: 4.2.4 (8) Writing the Setting Data (BCKUP), 4.2.4 (7) Reading Setting Data (RESTR)

5. Measurement and Recording (Unit Operation)

5.1 Overview

Measured values can be acquired in two ways: recording them in Power Sensor Station unit or acquiring them to the PC via network. This chapter explains recording in Power Sensor Station unit.

5.2 Selecting Operation Mode

RUN mode must be entered for power measurement.

Press the MODE key to change the operation mode to "RUN". "RUN" at the bottom right of the display turns ON.

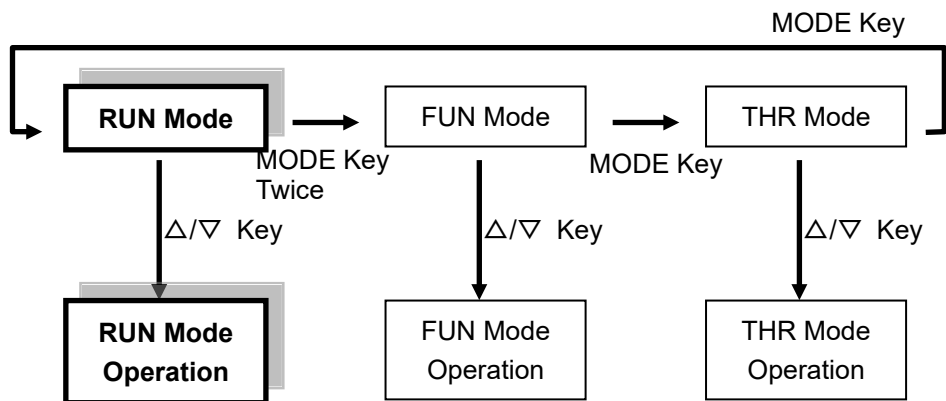

Note

Changing to other mode is prohibited during recording.

5.3 Screen Transition in RUN Mode

Pressing the Δ or ∇ key in RUN mode switches the display as shown below. Pressing the MODE key changes the operation mode.

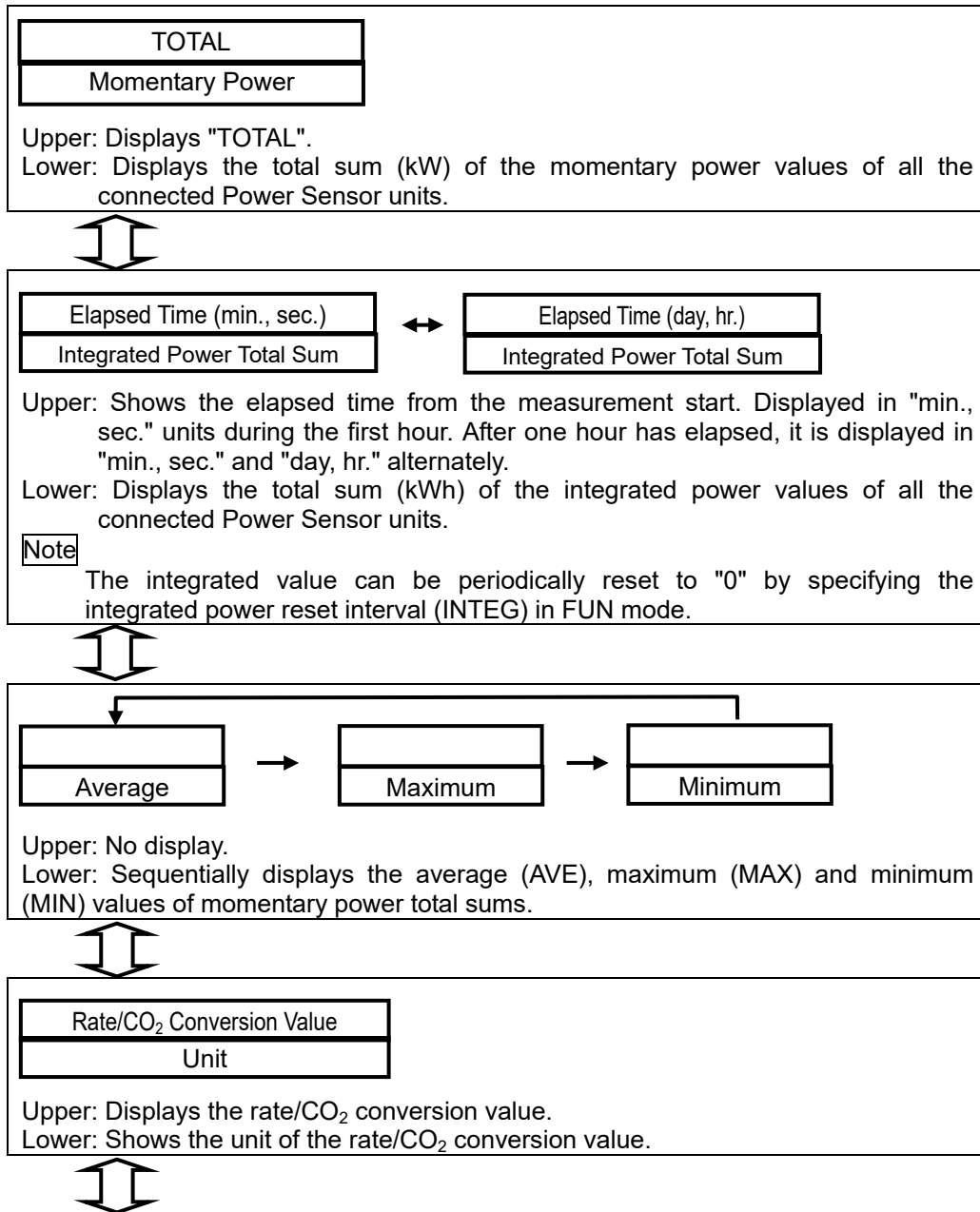

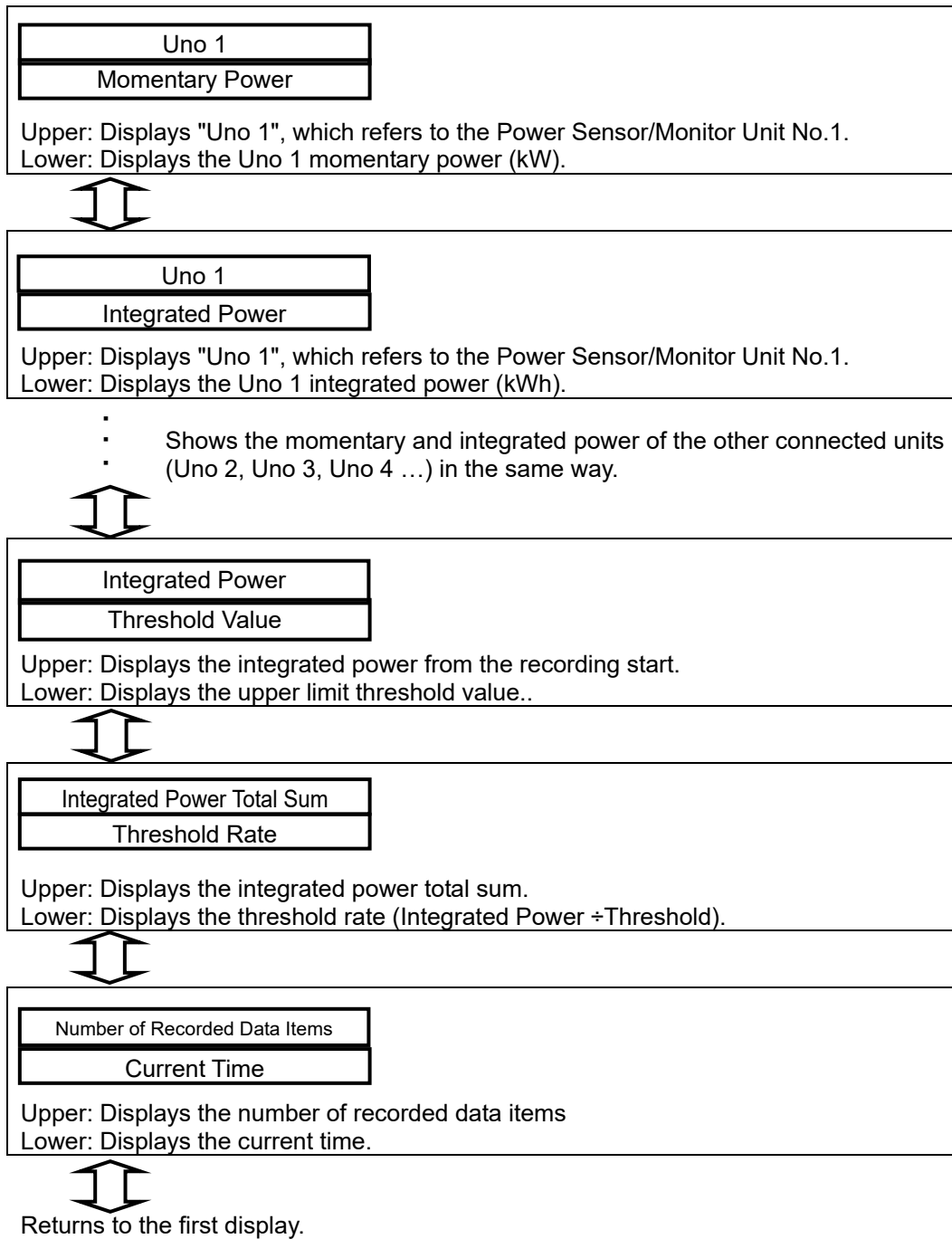

Note

- The "REC" indication turns ON during data recording.
- "ALM" turns ON when the measured value exceeds the upper limit threshold value or the alarm output is ON. To cancel the retained alarm, hold the MODE key.

5.4 Starting/Stopping Recording

5.4.1 Starting Recording

When holding the SET/REC/STOP key (for at least 3 seconds) in RUN mode, recording of power data starts and "REC" will be displayed.

The measured data is recorded and accumulated in the internal memory. They will be CSV file to an SD memory card when the SET/REC/STOP key is pressed.

Important

If recording starts with the recorded data remained in the internal memory, the remaining recorded data will be lost. To save the data, press the SET/REC/STOP key for less than 3 seconds before recording to output the data to an SD card. The station unit can be set to resume recording automatically when it restarts after a power failure or other reason. In this case, the unit outputs the data accumulated to the point of the reset to the SD memory card inserted to the unit. However, if any SD card is not inserted, the accumulated data is discarded.

To check the remaining data, press the ∇ or Δ key in RUN mode to locate the display in which the current time is shown at the lower row. Check its upper row, and its value is "0", then there is no data remaining in the internal memory.

Note

- The Power Failure REC Restoration function automatically resumes recording (if it is set to "ON") when the unit restarts after it was accidentally turned OFF during recording.
- An SD memory card must be placed in the station unit when the SET/REC/STOP key is pressed for data output during recording or when recording is stopped. It is not necessarily the case at the point when the unit starts recording.
- A shift to other mode is prohibited during recording. Stop recording when other mode than RUN mode should be entered.

5.4.2 Stopping Recording

The station unit stops recording if the SET/REC/STOP key is held (for 3 seconds or longer) during recording (i.e. the "REC" indication is ON). The data in the internal memory is output to the SD memory card and "REC" turns OFF.

Important

A write-enabled SD memory card must have been inserted in the slot when stopping recording. If a data output attempt fails, an error is output and recording is stopped without saving the data. To correct this, insert an SD card before resuming recording and press the SET/REC/STOP key to output the data.

The data accumulated so far is discarded unless it is output before starting recording.

5.5 Outputting File to SD Memory Card

Recorded data can be output to SD memory card files when any of the following cases happen.

- (a) The SET/REC/STOP is pressed (for less than 3 seconds) during recording. Recording in the internal memory continues.
- (b) The SET/REC/STOP key is held (for 3 seconds or longer) during recording. Recording in the internal memory stops.

Refer to: 5.4.2 Stopping Recording

- (c) The internal memory becomes full during recording. Recording in the internal memory continues. (The recording mode must have been set to "Continue mode".)

Refer to :4.2.4 (3) Recording Mode (REC)

- (d) The SET/REC/STOP key is pressed (for less than 3 seconds in RUN mode) during non-recording process, when recorded data remains in the internal memory.
- (e) The previous recorded data remains in the internal memory at power ON.
Such condition may occur when restarting the unit due to a power failure or reset switch being pressed.

5.6 Cancelling Alarm

"ALM" turns ON when the measured value exceeds the upper limit threshold or the alarm output is ON.

To cancel the retained alarm, hold the MODE key (for 3 seconds or longer).

6. Ratings and Performance

Item	Description
Connectable Power Sensor/Monitor	KM20-B40-FLK, KM50-C, KM50-E, KM100, KM-N1-FLK, KM-N2-FLK, KM-N3-FLK
Max. Number of Connectable Power Sensor/Monitor Units	31 units
Display	7-seg. 5-digit 2-step LCD display, auxiliary information indicator displays
Recording Interval	1 s, 2 s, 5 s, 10 s, 20 s, 30 s, 1 min.
Recorded data	Momentary power, Integrated power, Power factor, Sum of pulse input counts 1 and 2 ^{*1}
Operation Function	Integrated power total sum, integrated momentary power, electricity rate total sum
Recording Mode	Continue mode ^{*2} , Ring mode ^{*3}
External Output	Alarm output (Photocoupler output) ^{*4}
Communication Interface	Ethernet (10BASE-T, 100BASE-TX)
Memory Capacity (Internal)	Internal memory: approx. 200 data items (at maximum load); approx. 6800 data items ^{*5} (at minimum load)
Memory Capacity (External)	SD memory card with SDHC compatibility (measured value saving, set value saving and reading) Recommended SD memory card: HMC-SD291(2GB), HMC-SD491 (4GB) (manufactured by OMRON) ^{*6}
Power Supply	DC input: 24 VDC±10%, AC adapter: 100 to 240 VAC/50 to 60 Hz
Current Consumption	Max. 80 mA
Operating Temperature	Without Ethernet: -10°C to 40°C (no condensation or icing) With Ethernet: 0°C to 40°C (no condensation or icing)
Operating Humidity	20 to 85%RH (no condensation or icing)
Storage Temperature	-15°C to +60°C
Storage Humidity	20 to 85%RH (no condensation or icing)
Insulation Resistance	20 MΩ (with DC500V Megger)
Withstand Voltage	1000 VAC, 50/60 Hz, 1 min
Vibration Resistance	10 to 150 Hz, 0.7 mm double amplitude, acceleration: 50 m/s ² for each in X, Y and Z directions for 80 min ^{*7}
Shock Resistance	150 m/s ² in 6 directions (+/-X, +/-Y, and +/-Z directions), 3 times each ^{*7}
Material	ABS
Degree of Protection	IP30
Mounting	Magnet mounting, screw mounting, hook, free standing
Dimensions (WDH)	117.2 × 24.6 × 56.8 mm (Excluding protrusions)
Weight (in Package)	Approx. 500 g
Accessories	Instruction Sheet, Startup Guide, Alarm Output Connector ^{*8} , AC Adapter ^{*9*10} , DC cable ^{*10} , Ferrite core ^{*10} , Connection Cable

*1: Only supported for KM50-C and KM50-E.

*2: Automatically writes the data to the SD memory card when the internal memory reaches its capacity and continues recording until the SD card memory capacity reaches its limit. The unit stops operation if there is no SD memory card inserted when the internal memory reaches its capacity. (Recording can be resumed after inserting an SD memory card and outputting the data to it at a press of button.)

- *3: Continues the recording of the latest measured values until the internal memory reaches its capacity. (If the internal memory capacity exceeds the capacity, data is overwritten from the oldest one in the memory.)
- *4: Output when the integrated power upper limit specified in THR mode is exceeded.
- *5: The maximum load is applied when 31 KM50-□ units are connected; and the minimum load, when a single KM20-B40-FLK is connected.
- *6: When using third party SD memory card, please use industrial SD memory card (flash memory is SLC type) with high reliability and durability. Available SD memory card is SD standard or SDHC standard, Class 4 or higher, (SDXC standard cannot be used) You must confirm the operation of third party SD memory card yourself.
- *7: The vibration resistance when mounted using the ZN9-EM01-S magnets (separately sold): 10 to 55 Hz, 0.3mm double amplitude, acceleration: 20m/s^2 for each in X, Y and Z directions for 50 min. The installation place must be free from physical shock.
- *8: OMRON's XW4B-02B1-H1 connector.
- *9: The provided AC adapter must be used.
- *10: An AC adapter is included in ZN-KMX21. A DC cable and ferrite core are included in ZN-KMX21-A.

Appendix

Error Display List

Display Upper/Lower	Description	Troubleshooting
DATA E1100	Measured data writing failure	Failed to write recorded data to the SD memory card due to no free space or the card being removed during writing. Insert a writable SD memory card. Hold the MODE key for 3 seconds or more to cancel the error display. If this error occurs, insert a normal SD memory card and stop recording. Resume recording after checking that the data has been normally written to the SD memory card.
SEN E2001	Sensor error	Other sensors than those registered in the initialization process at the last startup are connected. Restart the station unit.
SEN E2002	Sensor communications error	Communication with the sensor failed. Check the wiring between the sensor and the main unit. To cancel the error display, press and hold the MODE key for 3 seconds or more.
SEN E2003	Sensor registration failed	Failed to register the sensor in the initial processing on startup. Check the wiring between the sensor and the main unit, and restart the main unit. If you turn on the power of the main unit before the sensor starts up, the sensor cannot be properly registered.
NO SD E3000	No SD memory card inserted	An SD memory card is not inserted. Insert a writable SD memory card. Hold the MODE key for 3 seconds or more to cancel the error display.
SDLCK E3002	Write-protected SD memory card	The SD memory card is write-protected. Replace it with a writable one. Hold the MODE key for 3 seconds or more to cancel the error display.
SD ER E3003	SD memory card recognition error	Failed to recognize the SD memory card. Insert a normal SD memory card. Hold the MODE key for 3 seconds or more to cancel the error display.
RESTR E5000	Invalid setting file data	The setting data in the SD memory card is invalid e.g. an invalid model type or setting values. Hold the MODE key for 3 seconds or more to cancel the error display.
BCKUP E5001	Setting file writing failure	Failed to write setting files to the SD memory card due to no free space or the card being write-protected. Insert a writable SD card. Hold the MODE key for 3 seconds or more to cancel the error display.

RESTR E5002	Setting file reading failure	There is no setting files contained in the SD memory card. Replace it with an SD memory card with setting files. Hold the MODE key for 3 seconds or more to cancel the error display.
HARD E****	Hardware error	There may be a failure on the hardware. Please contact the distributor or OMRON representative office. The displayed error code is required for identifying the problem.

Character Display List

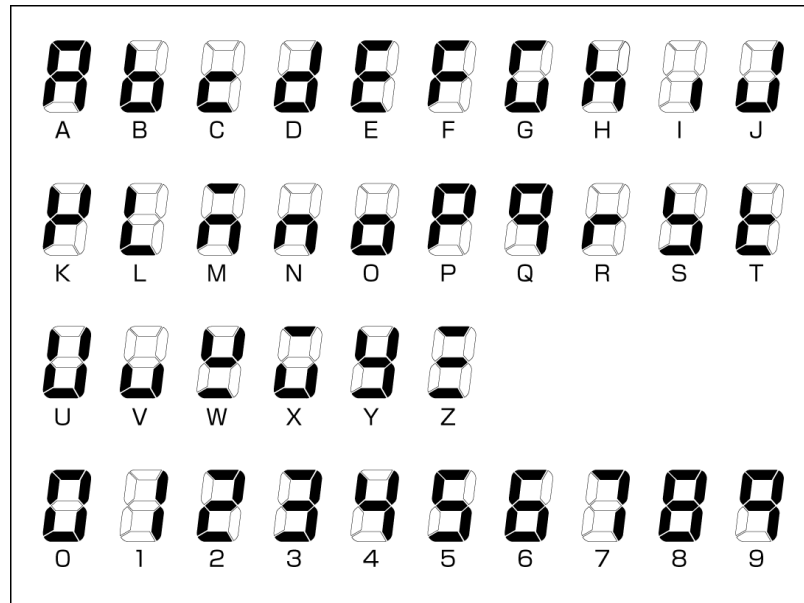

Display	String	Display	String	Display	String
cYcLE	CYCLE	t iNt	TIME	r iNg	RING
Un it	UNIT	oFF	OFF	int h	INT H
rEc	REC	on	ON	rESEt	RESET
intEG	INTEG	d iSP	DISP	donE	DONE
in it	INIT	norñ	NORM	dAtA	DATA
EtC	ETC	,P	IP	SEn	SEN
rEstR	RESTR	SUb	SUB	no Sd	NO SD
bCkUP	BCKUP	rAtE	RATE	SdLcK	SDLCK
cLoCk	CLOCK	conV	CONV	hARd	HARD
YEAr	YEAR	UtOFs	UTOFS	toTAL	TOTAL
month	MONTH	rERec	REREC		
dAY	DAY	cont	CONT		

Main Messages

SD Memory Card Folder Structure

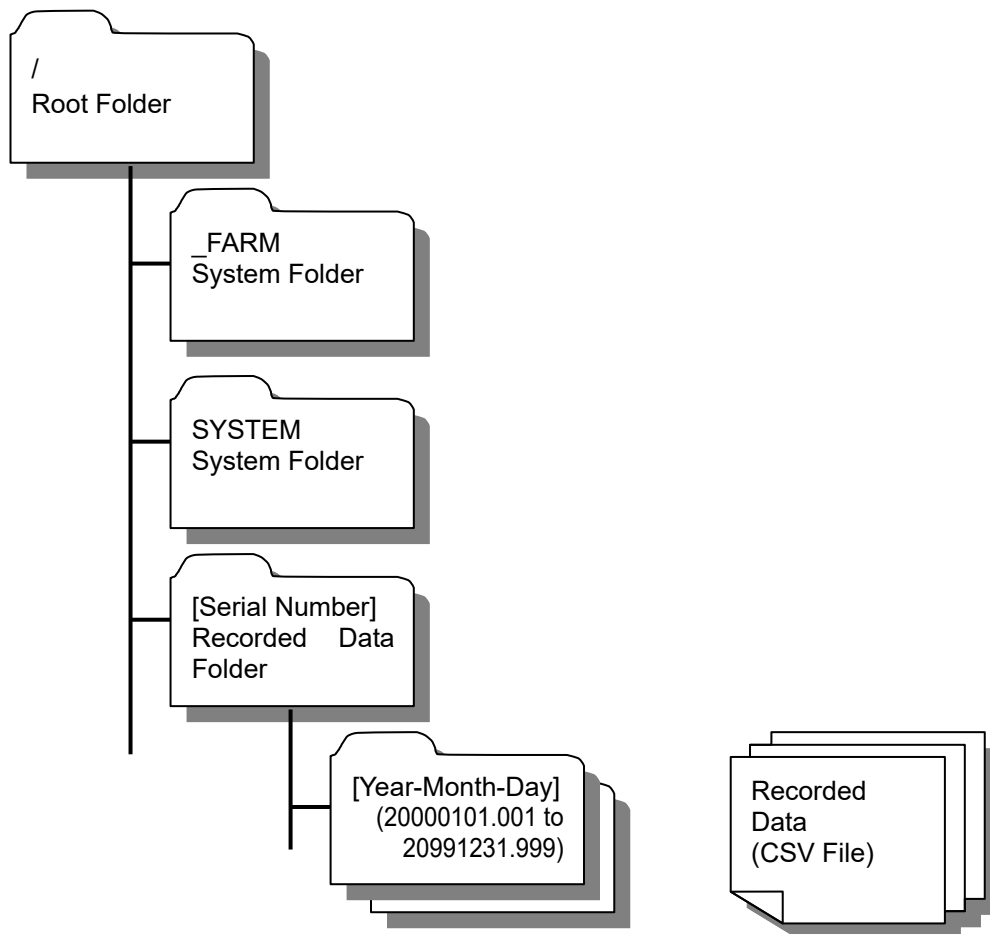

File/Folder Name	Description
_FARM	For system use. Do not modify the file names or the internal files.
SYSTEM	For system use. Do not modify the file names or the internal files.
[Serial Number]	Folder for storing recorded data. The folders are named with the serial numbers corresponding to the Power Sensor Station unit numbers.
[Year-Month-Day]	Sub folders for storing recorded data. Folder Name Structure: "Recorded time and date (YYYYMMDD format) + . + Serial No." Example: 20111001.001 The folder is written on October 1, 2011. Recorded data file is created in the CSV format. File Name Structure: "Hour-Minute-Second + Serial No.".CSV Example: 12345601.CSV The recorded data file is written at 12:24:56.

Installation Diagram

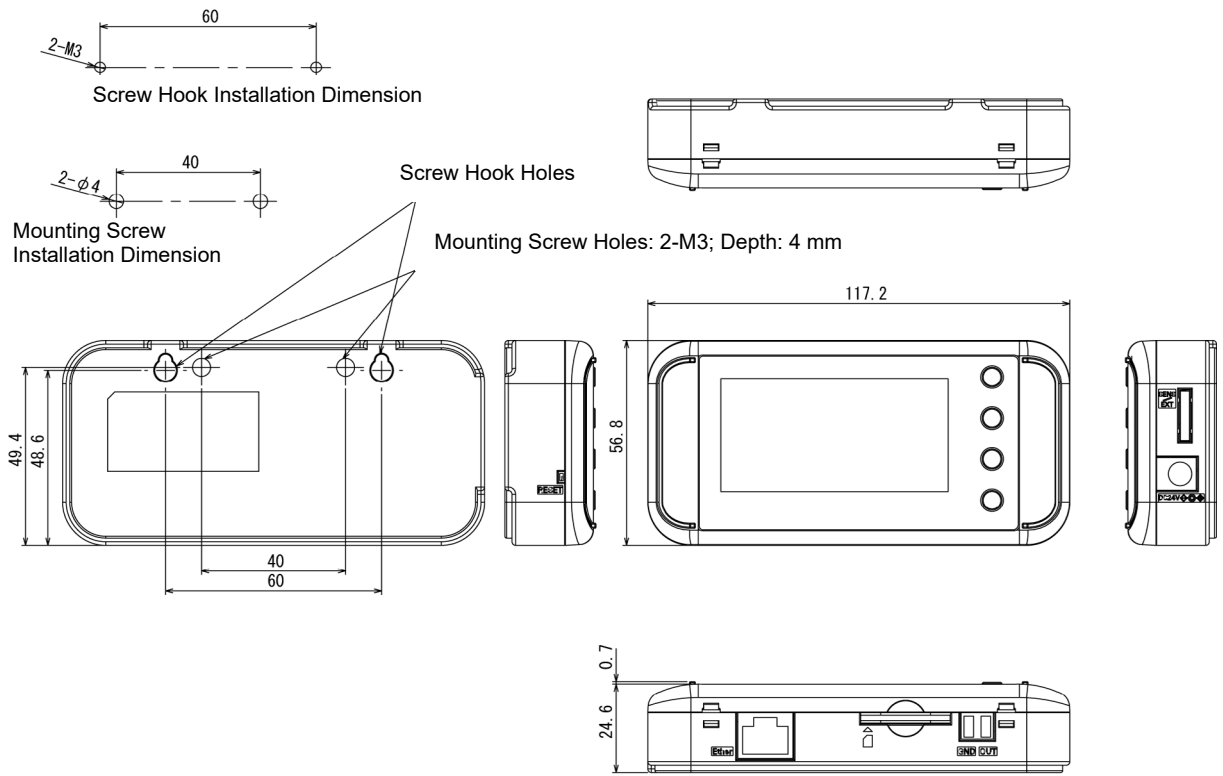

(Unit: mm)

Revision History

The specifications of this product are subject to changes without prior notice due to the addition of new functions or modification for improvement. These changes will be reflected in relevant manuals whenever such changes are made.

The revised manual contains the revision history with the manual revision codes and the revision descriptions.

Manual Revision Code

The manual revision code is provided at the lower right corner of the manual.

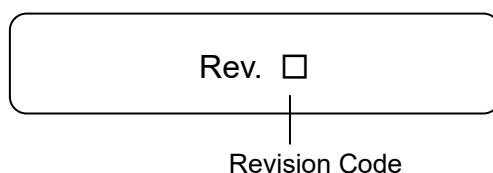

Revision History

Revision Code	Date	Description
A	October 2011	First edition
B	November 2012	Correction of clerical errors
C	December 2016	Revised due to change of PC software distribution method
D	January 2017	Correction of the description associated with the addition of connectable models
E	December 2018	Error addition by correction of function
F	March 2019	Revised due to change of Terms and Conditions Agreement

По вопросам продаж и поддержки обращайтесь:

Архангельск (8182)63-90-72
 Астана +7(7172)727-132
 Астрахань (8512)99-46-04
 Барнаул (3852)73-04-60
 Белгород (4722)40-23-64
 Брянск (4832)59-03-52
 Владивосток (423)249-28-31
 Волгоград (844)278-03-48
 Вологда (8172)26-41-59
 Воронеж (473)204-51-73
 Екатеринбург (343)384-55-89
 Иваново (4932)77-34-06
 Ижевск (3412)26-03-58
 Иркутск (395) 279-98-46

Казань (843)206-01-48
 Калининград (4012)72-03-81
 Калуга (4842)92-23-67
 Кемерово (3842)65-04-62
 Киров (8332)68-02-04
 Краснодар (861)203-40-90
 Красноярск (391)204-63-61
 Курск (4712)77-13-04
 Липецк (4742)52-20-81
 Магнитогорск (3519)55-03-13
 Москва (495)268-04-70
 Мурманск (8152)59-64-93
 Набережные Челны (8552)20-53-41
 Нижний Новгород (831)429-08-12

Новокузнецк (3843)20-46-81
 Новосибирск (383)227-86-73
 Омск (3812)21-46-40
 Орел (4862)44-53-42
 Оренбург (3532)37-68-04
 Пенза (8412)22-31-16
 Пермь (342)205-81-47
 Ростов-на-Дону (863)308-18-15
 Рязань (4912)46-61-64
 Самара (846)206-03-16
 Санкт-Петербург (812)309-46-40
 Саратов (845)249-38-78
 Севастополь (8692)22-31-93
 Симферополь (3652)67-13-56

Смоленск (4812)29-41-54
 Сочи (862)225-72-31
 Ставрополь (8652)20-65-13
 Сургут (3462)77-98-35
 Тверь (4822)63-31-35
 Томск (3822)98-41-53
 Тула (4872)74-02-29
 Тюмень (3452)66-21-18
 Ульяновск (8422)24-23-59
 Уфа (347)229-48-12
 Хабаровск (4212)92-98-04
 Челябинск (351)202-03-61
 Череповец (8202)49-02-64
 Ярославль (4852)69-52-93

Киргизия (996)312-96-26-47

Казахстан (772)734-952-31

Таджикистан (992)427-82-92-69

Эл. почта: orm@nt-rt.ru || Сайт: <http://omron.nt-rt.ru>