

Timer Interval Indicator K3HB-P

CSM_K3HB-P_DS_E_16_2

Digital Time Interval Meter for Measuring Passing Speed, Time, or Cycle between Two Points.



- Visual confirmation of judgement results through display colors that switch between red and green. *1
- Measures Wide Range of Pulse Interval Times
Measures, calculates, and displays pulse intervals between two points. Wide range for pulse interval measurements, from 10 ms to 3,200 s, max.
- Six Measurement Operations, Including Passing Speed, Time, and Cycle Measurement between Two Points
One Digital Time Interval Meter has six measurement functions, to support a variety of pulse interval measurement applications. Select the best function for your application from the following: Passing speed, cycle, time difference, time band, measuring length, and interval.
- DeviceNet models added to the series. *2

*1 Visual confirmation of judgement results is not supported on models that do not have an output or models that do not support DeviceNet.
You can change the display color by setting it, but you cannot switch it based on the judgement results.

*2 DeviceNet models have a depth of 97 mm.



For the most recent information on models that have been certified for safety standards, refer to your OMRON website.

Refer to *Safety Precautions for All Digital Panel Meters.*

Model Number Structure

Model Number Legend

Base Units and Optional Boards can be ordered individually or as sets.

Base Units

K3HB-P
1 5

- 1. Input Sensor Code**
NB: NPN input/voltage pulse input
PB: PNP input
- 5. Supply Voltage**
100-240 VAC: 100 to 240 VAC
24 VAC/VDC: 24 VAC/VDC

Optional Board

Sensor Power Supply/Output Boards

K33-
2

Relay/Transistor Output Boards

K34-
3

Event Input Boards

K35-
4

Base Units with Optional Boards

K3HB-P-
1 2 3 4 5

- 2. Sensor Power Supply/Output Type Code**
None: None
CPA: Relay output (PASS: SPDT) + Sensor power supply (12 VDC±10%, 80 mA) (See note 1.)
L1A: Linear current output (0 to 20 or 4 to 20 mA DC) + Sensor power supply (12 VDC±10%, 80 mA) (See note 2.)
L2A: Linear voltage output (0 to 5, 1 to 5, or 0 to 10 VDC) + Sensor power supply (12 VDC±10%, 80 mA) (See note 2.)
A: Sensor power supply (12 VDC ±10%, 80 mA)
FLK1A: Communications (RS-232C) + Sensor power supply (12 VDC±10%, 80 mA) (See note 2.)
FLK3A: Communications (RS-485) + Sensor power supply (12 VDC±10%, 80 mA) (See note 2.)

Note: 1. CPA can be combined with relay outputs only.
2. Only one of the following can be used by each Digital Indicator: RS-232C/RS-485 communications, a linear output, or DeviceNet communications.

3. Relay/Transistor Output Type Code

- None: None
C1: Relay contact (H/L: SPDT each)
C2: Relay contact (HH/H/LL/L: SPST-NO each)
T1: Transistor (NPN open collector: HH/H/PASS/L/LL)
T2: Transistor (PNP open collector: HH/H/PASS/L/LL)
BCD *:BCD output + transistor output (NPN open collector: HH/H/PASS/L/LL)
DRT: DeviceNet (See note 2.)
* A Special BCD Output Cable (sold separately) is required.

4. Event Input Type Code

- None: None
1: 5 inputs (HOLD/RESET), NPN open collector
2 *: 8 inputs (HOLD/RESET/BANK1/BANK2/BANK4), NPN open collector
3: 5 inputs (HOLD/RESET), PNP open collector
4 *: 8 inputs (HOLD/RESET/BANK1/BANK2/BANK4), PNP open collector
* There is no bank selection for "None" and "DeviceNet" types of "Transistor Output Type Code".

Note: The following combinations are not possible.

- Communications (FLK□A) + DeviceNet (DRT)
- Communications (FLK□A) + BCD output (BCD)
- Linear current/voltage (L□A) + DeviceNet (DRT)

Accessories (Sold Separately)

K32-DICN: Special Cable (for event inputs with 8-pin connector)

K32-BCD: Special BCD Output Cable

Watertight Cover

| Model |
|----------|
| Y92A-49N |

Rubber Packing

| Model |
|--------|
| K32-P1 |

Note: Rubber packing is provided with the Controller.

Specifications

■ Ratings

| Supply voltage | 100 to 240 VAC, 24 VAC/VDC, DeviceNet power supply: 24 VDC | | | | | | |
|--|---|--------------|---|-------------------|---|---------------|---|
| Allowable power supply voltage range | 85% to 110% of the rated power supply voltage, DeviceNet power supply: 11 to 25 VDC | | | | | | |
| Power consumption (See note 1.) | 100 to 240 VAC: 18 VA max. (max. load) 24 VAC/DC: 11 VA/7 W max. (max. load) | | | | | | |
| Current consumption | DeviceNet power supply: 50 mA max. (24 VDC) | | | | | | |
| Input | No-voltage contact, voltage pulse, open collector | | | | | | |
| External power supply | 12 VDC 10%, 80 mA (for models with external power supplies only) | | | | | | |
| Event inputs (See note 2.) | <table border="1"> <thead> <tr> <th>Hold input</th> <td>NPN open collector or no-voltage contact signal</td> </tr> <tr> <th>Reset input</th> <td>ON residual voltage: 2 V max. ON current at 0 Ω: 4 mA max.</td> </tr> <tr> <th>Bank input</th> <td>Max. applied voltage: 30 VDC max. OFF leakage current: 0.1 mA max.</td> </tr> </thead> </table> | Hold input | NPN open collector or no-voltage contact signal | Reset input | ON residual voltage: 2 V max. ON current at 0 Ω: 4 mA max. | Bank input | Max. applied voltage: 30 VDC max. OFF leakage current: 0.1 mA max. |
| Hold input | NPN open collector or no-voltage contact signal | | | | | | |
| Reset input | ON residual voltage: 2 V max. ON current at 0 Ω: 4 mA max. | | | | | | |
| Bank input | Max. applied voltage: 30 VDC max. OFF leakage current: 0.1 mA max. | | | | | | |
| Output ratings (depends on the model) | <table border="1"> <thead> <tr> <th>Relay output</th> <td>250 VAC, 30 VDC, 5 A (resistive load) Mechanical life expectancy: 5,000,000 operations, Electrical life expectancy: 100,000 operations</td> </tr> <tr> <th>Transistor output</th> <td>Maximum load voltage: 24 VDC, Maximum load current: 50 mA, Leakage current: 100 μA max.</td> </tr> <tr> <th>Linear output</th> <td>Linear output 0 to 20 mA DC, 4 to 20 mA DC: Load: 500 Ω max, Resolution: Approx. 10,000, Output error: ±0.5% FS Linear output 0 to 5 VDC, 1 to 5 VDC, 0 to 10 VDC: Load: 5 kΩ max, Resolution: Approx. 10,000, Output error: ±0.5% FS (1 V or less: ±0.15 V; no output for 0 V or less)</td> </tr> </thead> </table> | Relay output | 250 VAC, 30 VDC, 5 A (resistive load) Mechanical life expectancy: 5,000,000 operations, Electrical life expectancy: 100,000 operations | Transistor output | Maximum load voltage: 24 VDC, Maximum load current: 50 mA, Leakage current: 100 μA max. | Linear output | Linear output 0 to 20 mA DC, 4 to 20 mA DC: Load: 500 Ω max, Resolution: Approx. 10,000, Output error: ±0.5% FS Linear output 0 to 5 VDC, 1 to 5 VDC, 0 to 10 VDC: Load: 5 kΩ max, Resolution: Approx. 10,000, Output error: ±0.5% FS (1 V or less: ±0.15 V; no output for 0 V or less) |
| Relay output | 250 VAC, 30 VDC, 5 A (resistive load) Mechanical life expectancy: 5,000,000 operations, Electrical life expectancy: 100,000 operations | | | | | | |
| Transistor output | Maximum load voltage: 24 VDC, Maximum load current: 50 mA, Leakage current: 100 μA max. | | | | | | |
| Linear output | Linear output 0 to 20 mA DC, 4 to 20 mA DC: Load: 500 Ω max, Resolution: Approx. 10,000, Output error: ±0.5% FS Linear output 0 to 5 VDC, 1 to 5 VDC, 0 to 10 VDC: Load: 5 kΩ max, Resolution: Approx. 10,000, Output error: ±0.5% FS (1 V or less: ±0.15 V; no output for 0 V or less) | | | | | | |
| Display method | Negative LCD (backlit LED) display 7-segment digital display (Character height: PV: 14.2 mm (green/red); SV: 4.9 mm (green)) | | | | | | |
| Main functions | Scaling function, measurement operation selection, output hysteresis, output OFF delay, output test, teaching, display value selection, display color selection, key protection, bank selection, display refresh period, maximum/minimum hold, reset | | | | | | |
| Ambient operating temperature | -10 to 55°C (with no icing or condensation) | | | | | | |
| Ambient operating humidity | 25% to 85% | | | | | | |
| Storage temperature | -25 to 65°C (with no icing or condensation) | | | | | | |
| Altitude | 2,000 m max. | | | | | | |
| Accessories | Watertight packing, 2 fixtures, terminal cover, unit stickers, instruction manual. DeviceNet models also include a DeviceNet connector (Hirose HR31-5.08P-5SC(01)) and crimp terminals (Hirose HR31-SC-121) (See note 3.) | | | | | | |

Note: 1. DC power supply models require a control power supply capacity of approximately 1 A per Unit when power is turned ON. Particular attention is required when using two or more DC power supply models. The OMRON S8VS-series DC Power Supply Unit is recommended.

2. PNP input types are also available.

3. For K3HB-series DeviceNet models, use only the DeviceNet Connector included with the product. The crimp terminals provided are for Thin Cables.

По вопросам продаж и поддержки обращайтесь:

Архангельск (8182)63-90-72
Астана +7(7172)727-132
Астрахань (8512)99-46-04
Барнаул (3852)73-04-60
Белгород (4722)40-23-64
Брянск (4832)59-03-52
Владивосток (423)249-28-31
Волгоград (844)278-03-48
Вологда (8172)26-41-59
Воронеж (473)204-51-73
Екатеринбург (343)384-55-89
Иваново (4932)77-34-06
Ижевск (3412)26-03-58
Иркутск (395) 279-98-46

Казань (843)206-01-48
Калининград (4012)72-03-81
Калуга (4842)92-23-67
Кемерово (3842)65-04-62
Киров (8332)68-02-04
Краснодар (861)203-40-90
Красноярск (391)204-63-61
Курск (4712)77-13-04
Липецк (4742)52-20-81
Магнитогорск (3519)55-03-13
Москва (495)268-04-70
Мурманск (8152)59-64-93
Набережные Челны (8552)20-53-41
Нижний Новгород (831)429-08-12

Новокузнецк (3843)20-46-81
Новосибирск (383)227-86-73
Омск (3812)21-46-40
Орел (4862)44-53-42
Оренбург (3532)37-68-04
Пенза (8412)22-31-16
Пермь (342)205-81-47
Ростов-на-Дону (863)308-18-15
Рязань (4912)46-61-64
Самара (846)206-03-16
Санкт-Петербург (812)309-46-40
Саратов (845)249-38-78
Севастополь (8692)22-31-93
Симферополь (3652)67-13-56

Смоленск (4812)29-41-54
Сочи (862)225-72-31
Ставрополь (8652)20-65-13
Сургут (3462)77-98-35
Тверь (4822)63-31-35
Томск (3822)98-41-53
Тула (4872)74-02-29
Тюмень (3452)66-21-18
Ульяновск (8422)24-23-59
Уфа (347)229-48-12
Хабаровск (4212)92-98-04
Челябинск (351)202-03-61
Череповец (8202)49-02-64
Ярославль (4852)69-52-93

Киргизия (996)312-96-26-47

Казахстан (772)734-952-31

Таджикистан (992)427-82-92-69

Эл. почта: orm@nt-rt.ru || Сайт: <http://omron.nt-rt.ru>

■ Characteristics

| Display range | -19,999 to 99,999 | | | | | | | | | | | | | | | | |
|---|--|--|-----------------------|-----------------------|--------------------|-----------------|-------------|-----------------|-------------|-------------|---|-------------|------------|-------|--------|-------------|------------|
| Measurement accuracy (at 23±5°C) | ±0.08% rgd ±1 digit (for voltage pulse/open collector sensors) | | | | | | | | | | | | | | | | |
| Measurement range | Functions F1, F3, and F4: (Interval between input pulses) 10 ms to 3,200 s Function F2: (Interval between input pulses) 20 ms to 3,200 s Functions F5, F6: (Number of input pulses) 0 to 4 gigacounts | | | | | | | | | | | | | | | | |
| Input signals | <ul style="list-style-type: none"> • Contact input (dry contact input) (30 Hz max. with ON/OFF pulse width of 15 ms min.) • No contact voltage pulse | | | | | | | | | | | | | | | | |
| | Mode | <table border="1"> <thead> <tr> <th>Mode</th> <th>Input frequency range</th> <th>ON/OFF pulse width</th> <th>ON voltage</th> <th>OFF voltage</th> <th>Input impedance</th> </tr> </thead> <tbody> <tr> <td>F1 to F4</td> <td>0 to 50 kHz</td> <td>9 μs min.</td> <td rowspan="2">4.5 to 30 V</td> <td rowspan="2">-30 to 2 V</td> <td rowspan="2">10 kΩ</td> </tr> <tr> <td>F5, F6</td> <td>0 to 30 kHz</td> <td>16 μs min.</td> </tr> </tbody> </table> | Mode | Input frequency range | ON/OFF pulse width | ON voltage | OFF voltage | Input impedance | F1 to F4 | 0 to 50 kHz | 9 μs min. | 4.5 to 30 V | -30 to 2 V | 10 kΩ | F5, F6 | 0 to 30 kHz | 16 μs min. |
| | Mode | Input frequency range | ON/OFF pulse width | ON voltage | OFF voltage | Input impedance | | | | | | | | | | | |
| | F1 to F4 | 0 to 50 kHz | 9 μs min. | 4.5 to 30 V | -30 to 2 V | 10 kΩ | | | | | | | | | | | |
| F5, F6 | 0 to 30 kHz | 16 μs min. | | | | | | | | | | | | | | | |
| Mode | <table border="1"> <thead> <tr> <th>Mode</th> <th>Input frequency range</th> <th>ON/OFF pulse width</th> </tr> </thead> <tbody> <tr> <td>F1 to F4</td> <td>0 to 50 kHz</td> <td>9 μs min.</td> </tr> <tr> <td>F5, F6</td> <td>0 to 30 kHz</td> <td>16 μs min.</td> </tr> </tbody> </table> | Mode | Input frequency range | ON/OFF pulse width | F1 to F4 | 0 to 50 kHz | 9 μs min. | F5, F6 | 0 to 30 kHz | 16 μs min. | Note: The Digital Time Interval Meter will malfunction if a pulse greater than the input frequency range is input. SYSERR may appear on the display. | | | | | | |
| Mode | Input frequency range | ON/OFF pulse width | | | | | | | | | | | | | | | |
| F1 to F4 | 0 to 50 kHz | 9 μs min. | | | | | | | | | | | | | | | |
| F5, F6 | 0 to 30 kHz | 16 μs min. | | | | | | | | | | | | | | | |
| Mode | <table border="1"> <thead> <tr> <th>Mode</th> <th>Input frequency range</th> <th>ON/OFF pulse width</th> </tr> </thead> <tbody> <tr> <td>F1 to F4</td> <td>0 to 50 kHz</td> <td>9 μs min.</td> </tr> <tr> <td>F5, F6</td> <td>0 to 30 kHz</td> <td>16 μs min.</td> </tr> </tbody> </table> | Mode | Input frequency range | ON/OFF pulse width | F1 to F4 | 0 to 50 kHz | 9 μs min. | F5, F6 | 0 to 30 kHz | 16 μs min. | | | | | | | |
| Mode | Input frequency range | ON/OFF pulse width | | | | | | | | | | | | | | | |
| F1 to F4 | 0 to 50 kHz | 9 μs min. | | | | | | | | | | | | | | | |
| F5, F6 | 0 to 30 kHz | 16 μs min. | | | | | | | | | | | | | | | |
| Open collector | | | | | | | | | | | | | | | | | |
| Connectable sensors | ON residual voltage: 3 V max. OFF leakage current: 1.5 mA max. Load current: Must have a switching capacity of 20 mA or higher. Must be able to properly switch load currents of 5 mA or less. | | | | | | | | | | | | | | | | |
| Comparative output response time (transistor output) | 2 ms max. (time until the comparative output is made when there is a forced sudden change in the input signal from 15% to 95% or 95% to 15%) | | | | | | | | | | | | | | | | |
| Linear output response time | 10 ms max. (time until the final analog output value is reached when there is a forced sudden change in the input signal from 15% to 95% or 95% to 15%) | | | | | | | | | | | | | | | | |
| Insulation resistance | 20 MΩ min. (at 500 VDC) | | | | | | | | | | | | | | | | |
| Dielectric strength | 2,300 VAC for 1 min between external terminals and case | | | | | | | | | | | | | | | | |
| Noise immunity | 100 to 240 VAC models: ±1,500 V at power supply terminals in normal or common mode (waveform with 1-ns rising edge and pulse width of 1 μs/100 ns) 24 VAC/VDC models: ±1,500 V at power supply terminals in normal or common mode (waveform with 1-ns rising edge and pulse width of 1 μs/100 ns) | | | | | | | | | | | | | | | | |
| Vibration resistance | Frequency: 10 to 55 Hz; Acceleration: 50 m/s ² , 10 sweeps of 5 min each in X, Y, and Z directions | | | | | | | | | | | | | | | | |
| Shock resistance | 150 m/s ² (100 m/s ² for relay outputs) 3 times each in 3 axes, 6 directions | | | | | | | | | | | | | | | | |
| Weight | Approx. 300 g (Base Unit only) | | | | | | | | | | | | | | | | |
| Degree of protection | Front panel | Conforms to NEMA 4X for indoor use (equivalent to IP66) | | | | | | | | | | | | | | | |
| | Rear case | IP20 | | | | | | | | | | | | | | | |
| | Terminals | IP00 + finger protection (VDE0106/100) | | | | | | | | | | | | | | | |
| Memory protection | EEPROM (non-volatile memory) Number of rewrites: 100,000 | | | | | | | | | | | | | | | | |
| Applicable standards | UL61010-1, CSA C22.2 No. 61010-1-04 EN61010-1 (IEC61010-1): Pollution degree 2/Overvoltage category II EN61326-1 | | | | | | | | | | | | | | | | |
| EMC | EMI: EN61326-1 Industrial electromagnetic environment Electromagnetic radiation interference CISPR 11 Group 1, Class A Terminal interference voltage CISPR 11 Group 1, Class A EMS: EN61326-1 Industrial electromagnetic environment Electrostatic Discharge Immunity EN61000-4-2: 4 kV (contact), 8 kV (in air) Radiated Electromagnetic Field Immunity EN61000-4-3: 10 V/m sine wave amplitude modulation (80 MHz to 1 GHz, 1.4GHz to 2 GHz) Electrical Fast Transient/Burst Noise Immunity EN61000-4-4: 2 kV (power line), 1 kV (I/O signal line) Surge Immunity EN61000-4-5: 1 kV with line (power line), 2 kV with ground (power line) Conducted Disturbance Immunity EN61000-4-6: 3 V (0.15 to 80 MHz) Power Frequency Magnetic Immunity EN61000-4-8: 30 A/m (50 Hz) continuous time Voltage Dips and Interruptions Immunity EN61000-4-11: 0.5 cycle, 0°/180°, 100% (rated voltage) | | | | | | | | | | | | | | | | |

Operation

Functions (Operating Modes)

F1 to F6

These functions use the internal system clock to measure the time between pulses or the pulse ON time and then display time measurements or a variety of other calculations.

| Function name | Function No. |
|------------------|--------------|
| Passing speed | F1 |
| Cycle | F2 |
| Time difference | F3 |
| Time band | F4 |
| Measuring length | F5 |
| Interval | F6 |

Example: F1 Passing Speed

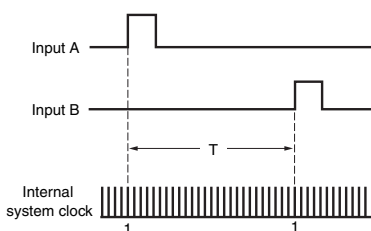

The time (T) between input A pulse and input B pulse is measured by the internal system clock. If, for example, the system clock measures 100,000 counts during time T, then

$$T = 1 \text{ system clock count } (0.5 \mu\text{s}) \times 100,000$$

$$T = 0.05 \text{ s}$$

F1 (the passing speed) is calculated internally using the formula $\frac{1}{T} \times 60$ (m/min), and the display, in this example, would be $\frac{1}{0.05 \text{ s}} \times 60 =$

$$1200 \text{ (m/min).}$$

| Function | Operation | Operation image (application) |
|-----------------------|---|--|
| F1 Passing speed | <p>The reciprocal of the time (T) from input A ON to input B ON is multiplied by 60 and displayed. Display value $D = 1/T \times 60 \times \alpha$, α: Prescaling value</p> <ul style="list-style-type: none"> Recovery time (T^R) of 20 ms is required before starting the next measurement. <p>(Display unit: mm/s, m/s m/min, km/h, etc.)</p> | <p>Measuring workpiece passing speed between A and B</p> |
| F2 Cycle | <p>Measures and displays input A cycle (T). Display value $D = T \times \alpha$, α: Prescaling value</p> <p>Measurement range: 20 ms to 3,200 s</p> <p>(Display unit: ms, s, min., min.s.1/10 s)</p> | <p>Measuring feed cycles for parts</p> |
| F3 Time difference | <p>Displays the time (T) from input A ON to input B ON. Display value $D = T \times \alpha$, α: Prescaling value</p> <p>Measurement range: 10 ms to 3,200 s</p> <ul style="list-style-type: none"> Recovery time (T^R) of 20 ms is required before starting the next measurement. <p>(Display unit: ms, s, min., min.s.1/10 s)</p> | <p>Measuring workpiece passing time between A and B</p> <p>Measuring the length of a workpiece step by changing prescale values.</p> |

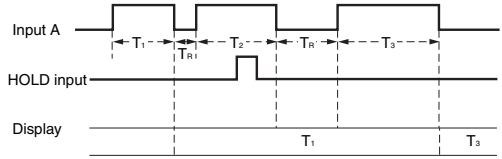
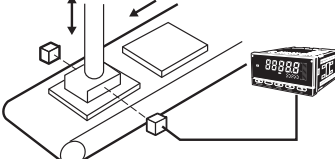
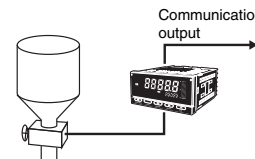
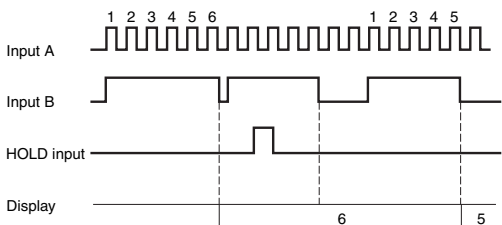
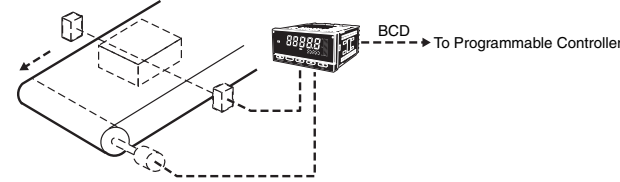
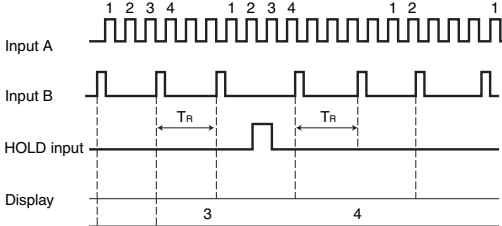
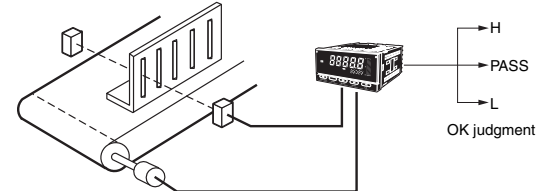
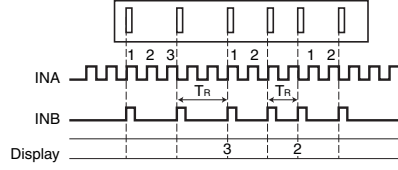
| Function | Operation | Operation image (application) |
|------------------------|--|---|
| F4 Time band | <p>Displays input A ON time (T). Display value $D = T \times \alpha$, α: Prescaling value</p>  <p>Measurement range: 10 ms to 3,200 s</p> <ul style="list-style-type: none"> Recovery time (T_R) of 20 ms is required before starting the next measurement. <p>Display unit: ms, s, min., min.s.1/10 s</p> | <p>Monitoring the ON time of a printing press</p>  <p>Managing the valve release time</p>  |
| F5 Measuring length | <p>Displays the number of input A pulses while input B is ON. Display value $D = C \times \alpha$, C: Pulse value α: Prescaling value</p>  <ul style="list-style-type: none"> Recovery time (T_R) of 20 ms is required before starting the next measurement. <p>Display unit: mm, cm, m, etc.</p> | <p>Measuring workpiece length</p>  |
| F6 Interval | <p>Displays the number of input A pulses from when input B turns ON until input B turns ON again. Measurement is made every other time input B turns ON. Display value $D = C \times \alpha$, C: Pulse value α: Prescaling value</p>  <ul style="list-style-type: none"> Recovery time (T_R) of 20 ms is required before starting the next measurement. <p>Display unit: mm, cm, m, etc.</p> | <p>Measuring slit intervals</p>   |

What Is Prescaling?

To make calculations using the input pulse to display the passing speed between two points, the distance between the two points and the display unit must be set and the internally measured time multiplied by a certain coefficient. This coefficient is called the prescale value. (For information on settings details, refer to the User's Manual.)

Time Unit Settings

| Setting | Meaning |
|----------|--|
| 0FF | Seconds display when prescaling = 1.0000 |
| nLn | Minutes display when prescaling = 1.0000 |
| H.n.n.ss | h.mm.ss display |
| n.n.ss.d | mm.ss.d display (d = tenths of a second) |

Input Type Setting

| | NO: Voltage pulse high | NC: Voltage pulse low |
|-----------------------------------|------------------------|-----------------------|
| No-contact or voltage pulse input | 00 | 01 |
| Contact | 10 | 11 |

Note: Set to 10 or 11 when there is a large variation in the display. The largest measurement range is 30 Hz.

Common Specifications

Event Input Ratings

| | |
|-------------------|--|
| K3HB-P/-C | HOLD, RESET, BANK1, BANK2, BANK4 |
| Contact | ON: 1 k Ω max., OFF: 100 k Ω min. |
| No-contact | ON residual voltage: 2 V max. OFF leakage current: 0.1 mA max. Load current: 4 mA max. Maximum applied voltage: 30 VDC max. |

Output Ratings

Contact Output

| Item | Resistive loads (250 VAC, $\cos\phi=1$; 30 VDC, L/R=0 ms) | Inductive loads (250 VAC, closed circuit, $\cos\phi=0.4$; 30 VDC, L/R=7 ms) |
|-----------------------------------|--|---|
| Rated load | 5 A at 250 VAC 5 A at 30 VDC | 1 A at 250 VAC 1 A at 30 VDC |
| Mechanical life expectancy | 5,000,000 operations | |
| Electrical life expectancy | 100,000 operations | |

Transistor Outputs

| | |
|-----------------------------|------------------|
| Maximum load voltage | 24 VDC |
| Maximum load current | 50 mA |
| Leakage current | 100 μ A max. |

Linear Output

| Item | Outputs | 0 to 20 mA | 4 to 20 mA | 0 to 5 V | 1 to 5 V | 0 to 10 V |
|---------------------------------|---------|-------------------|------------|---|----------|-----------|
| Allowable load impedance | | 500 Ω max. | | 5 k Ω min. | | |
| Resolution | | Approx. 10,000 | | | | |
| Output error | | $\pm 0.5\%$ FS | | $\pm 0.5\%$ FS (± 0.15 V for 1 V or less and no output for 0 V) | | |

Serial Communications Output

| Item | Type | RS-232C, RS-485 |
|-------------------------------|------|---|
| Communications method | | Half duplex |
| Synchronization method | | Start-stop synchronization (asynchronous) |
| Baud rate | | 9600/19200/38400 bps |
| Transmission code | | ASCII |
| Data length | | 7 bits or 8 bits |
| Stop bit length | | 2 bits or 1 bit |
| Error detection | | Vertical parity and FCS |
| Parity check | | Odd, even |

BCD Output I/O Ratings

(Input Signal Logic: Negative)

| I/O signal name | | Item | Rating |
|-----------------|----------------------------|------------------------------------|---|
| Inputs | REQUEST | Input signal | No-voltage contact input |
| | HOLD | Input current for no-voltage input | 10 mA |
| | MAX MIN RESET | Signal level | ON voltage: 1.5 V max. OFF voltage: 3 V min. |
| Outputs | DATA | Maximum load voltage | 24 VDC |
| | POLARITY | Maximum load current | 10 mA |
| | OVER | Leakage current | 100 μ A max. |
| | DATA VALID | | |
| | RUN | | |
| | HH H PASS L LL | Maximum load voltage | 24 VDC |
| | Maximum load current | 50 mA | |
| | Leakage current | 100 μ A max. | |

Refer to the *K3HB Communications User's Manual* (Cat. No. N129) for details on serial and DeviceNet communications.

DeviceNet Communications

| Communications protocol | | Conforms to DeviceNet | | | | | | | | | | | | | | | | | | |
|--|----------------------------------|--|-------------------------------|--|-----------|-----------------------|-------------------------|-------------------------------|----------|----------------------------|----------|-----------|----------|----------------------------|----------|-----------|----------|----------------------------|----------|------------|
| Supported communications | Remote I/O communications | Master-Slave connection (polling, bit-strobe, COS, cyclic) Conforms to DeviceNet communications standards. | | | | | | | | | | | | | | | | | | |
| | I/O allocations | Allocate any I/O data using the Configurator. Allocate any data, such as DeviceNet-specific parameters and variable area for Digital Indicators. Input area: 2 blocks, 60 words max. Output area: 1 block, 29 words max. (The first word in the area is always allocated for the Output Execution Enabled Flags.) | | | | | | | | | | | | | | | | | | |
| | Message communications | Explicit message communications CompoWay/F communications commands can be executed (using explicit message communications) | | | | | | | | | | | | | | | | | | |
| Connection methods | | Combination of multi-drop and T-branch connections (for trunk and drop lines) | | | | | | | | | | | | | | | | | | |
| Baud rate | | DeviceNet: 500, 250, or 125 Kbps (automatic follow-up) | | | | | | | | | | | | | | | | | | |
| Communications media | | Special 5-wire cable (2 signal lines, 2 power supply lines, 1 shield line) | | | | | | | | | | | | | | | | | | |
| Communications distance | | <table border="1"> <thead> <tr> <th>Baud rate</th> <th>Network length (max.)</th> <th>Drop line length (max.)</th> <th>Total drop line length (max.)</th> </tr> </thead> <tbody> <tr> <td>500 Kbps</td> <td>100 m max. (100 m max.)</td> <td>6 m max.</td> <td>39 m max.</td> </tr> <tr> <td>250 Kbps</td> <td>100 m max. (250 m max.)</td> <td>6 m max.</td> <td>78 m max.</td> </tr> <tr> <td>125 Kbps</td> <td>100 m max. (500 m max.)</td> <td>6 m max.</td> <td>156 m max.</td> </tr> </tbody> </table> <p>The values in parentheses are for Thick Cable.</p> | | | Baud rate | Network length (max.) | Drop line length (max.) | Total drop line length (max.) | 500 Kbps | 100 m max. (100 m max.) | 6 m max. | 39 m max. | 250 Kbps | 100 m max. (250 m max.) | 6 m max. | 78 m max. | 125 Kbps | 100 m max. (500 m max.) | 6 m max. | 156 m max. |
| Baud rate | Network length (max.) | Drop line length (max.) | Total drop line length (max.) | | | | | | | | | | | | | | | | | |
| 500 Kbps | 100 m max. (100 m max.) | 6 m max. | 39 m max. | | | | | | | | | | | | | | | | | |
| 250 Kbps | 100 m max. (250 m max.) | 6 m max. | 78 m max. | | | | | | | | | | | | | | | | | |
| 125 Kbps | 100 m max. (500 m max.) | 6 m max. | 156 m max. | | | | | | | | | | | | | | | | | |
| Communications power supply | | 24-VDC DeviceNet power supply | | | | | | | | | | | | | | | | | | |
| Allowable voltage fluctuation range | | 11 to 25-VDC DeviceNet power supply | | | | | | | | | | | | | | | | | | |
| Current consumption | | 50 mA max. (24 VDC) | | | | | | | | | | | | | | | | | | |
| Maximum number of nodes | | 64 (DeviceNet Configurator is counted as one node when connected.) | | | | | | | | | | | | | | | | | | |
| Maximum number of slaves | | 63 | | | | | | | | | | | | | | | | | | |
| Error control checks | | CRC errors | | | | | | | | | | | | | | | | | | |
| DeviceNet power supply | | Supplied from DeviceNet communications connector | | | | | | | | | | | | | | | | | | |

Connections

External Connection Diagrams Terminal Arrangements

Note: Refer to *Internal Block Diagram* on page 10 for information on isolation.

A Operating Power Supply

100 to 240 VAC
24 VAC/VDC

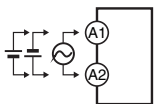

*Check the required power supply type.

B Sensor Power Supply/Output

Sensor power supply + PASS output

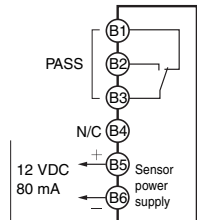

<CPA>

Sensor power supply + linear output

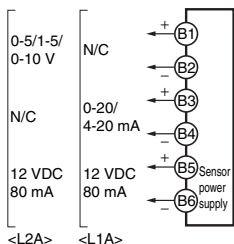

<L2A> <L1A>

Sensor power supply

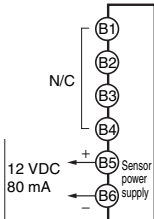

<A>

Sensor power supply + communications

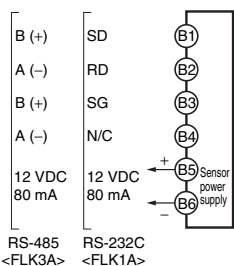

C Relays, Transistors, BCD and DeviceNet

Relay Outputs <C1>

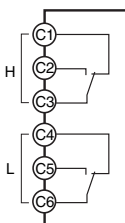

Relay Outputs <C2>

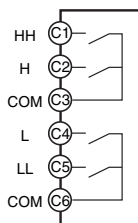

Transistor Outputs <T1> <T2>

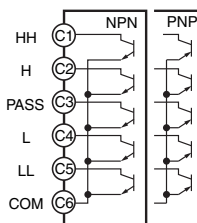

DeviceNet Connector (Included) <DRT>

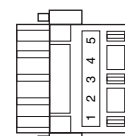

- 1: V- (Power supply cable: Black)
 - 2: CAN L (Communications cable: Blue)
 - 3: Shield
 - 4: CAN H (Communications cable: White)
 - 5: V+ (Power supply cable: Red)
- Applicable Connector:
HR31-5.08P-SSC (01)
(HIROSE ELECTRIC CO., LTD.)
* Attach the provided crimp terminals.

BCD (NPN Open Collector): <BCD>
Special Cable (Sold separately)
K32-BCD (OMRON)
(HDR-E50MAG1 with 0.3-m cable)

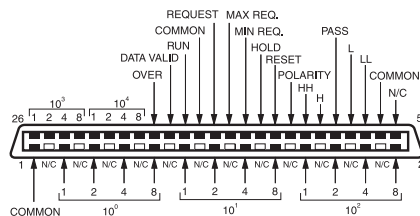

The BCD COMMON is shared.
The pins indicated in the above diagram as blank (white) boxes have been removed.

* Only one of the following can be used for each Digital Indicator: communications, BCD, or DeviceNet.

Contact Outputs

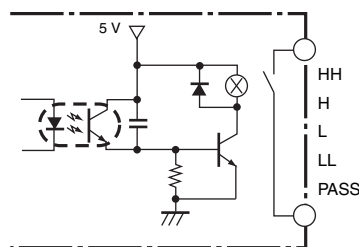

Transistor Outputs (NPN Open Collector)

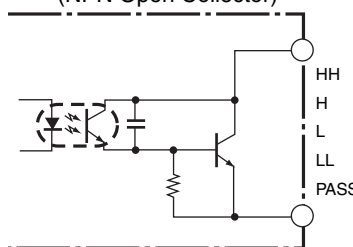

Safety Standards Conformance

- Always use a EN/IEC-compliant power supply with reinforced insulation or double insulation for the DeviceNet power supply.
- The product must be used indoors for the above applicable standards to apply.

E Pulse Inputs

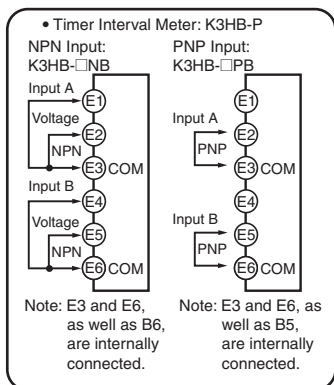

NPN Input Model

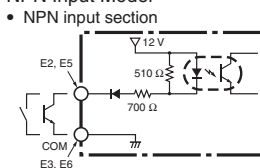

PNP Input Model

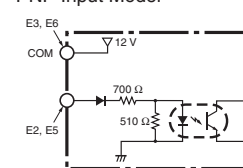

Connectable Sensors

ON residual voltage: 3 V
 OFF leakage current: 1.5 mA max.

• Voltage pulse input section

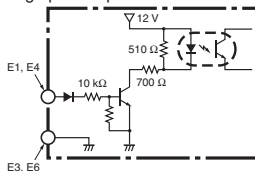

Note: A 2-wire DC sensor can also be connected. Check the ratings and characteristics tables, however, for the connection conditions.

Connectable Sensors

ON voltage: 4.5 to 30 V
 OFF voltage: -30 to 2 V

D Event Inputs

Models with Terminal Blocks

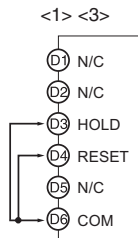

Models with Connectors

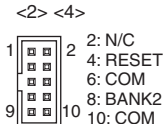

- Applicable Connector (Sold separately) XG4M-1030 (OMRON)
- Special Cable (Sold separately) K32-DICN (OMRON) (XG4M-1030 with 3-m cable)

- Use terminal pin D6 as the common terminal.
 - Use NPN open collector or no-voltage contacts for event input.
- PNP types are also available.

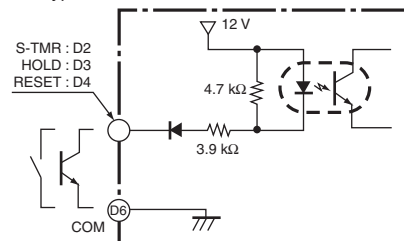

BCD Output Cable

| Model | Shape | Pin arrangement |
|---------|--|-----------------|
| K32-BCD | <p>Cover: HDR-E50LPA5 (manufactured by Honda Tsushin Co., Ltd) Connector: HDR-E50MAG1 (manufactured by Honda Tsushin Co., Ltd)</p> <p>D-sub connector (37-pin female) Cover: 17JE-37H-1A (manufactured by DDK) Connector: Equivalent to 17JE-13370-02 (manufactured by DDK) Stud: 17L-002A (manufactured by DDK)</p> | |

Note: The BCD Output Cable has a D-sub plug. Cover: 17JE-37H-1A (manufactured by DDK); Connector: equivalent to 17JE-23370-02 (D1) (manufactured by DDK)

Special Cable (for Event Inputs with 8-pin Connector)

| Model | Appearance | Wiring | | | | | | | | | | | | | | | | | | | | | | |
|----------|-------------|--|---------|-------------|---|-----|---|-------|---|------|---|-------|---|-----|---|-----|---|-------|---|-------|---|-------|----|-----|
| K32-DICN | | <table border="1"> <thead> <tr> <th>Pin No.</th> <th>Signal name</th> </tr> </thead> <tbody> <tr><td>1</td><td>N/C</td></tr> <tr><td>2</td><td>S-TMR</td></tr> <tr><td>3</td><td>HOLD</td></tr> <tr><td>4</td><td>RESET</td></tr> <tr><td>5</td><td>N/C</td></tr> <tr><td>6</td><td>COM</td></tr> <tr><td>7</td><td>BANK4</td></tr> <tr><td>8</td><td>BANK2</td></tr> <tr><td>9</td><td>BANK1</td></tr> <tr><td>10</td><td>COM</td></tr> </tbody> </table> | Pin No. | Signal name | 1 | N/C | 2 | S-TMR | 3 | HOLD | 4 | RESET | 5 | N/C | 6 | COM | 7 | BANK4 | 8 | BANK2 | 9 | BANK1 | 10 | COM |
| Pin No. | Signal name | | | | | | | | | | | | | | | | | | | | | | | |
| 1 | N/C | | | | | | | | | | | | | | | | | | | | | | | |
| 2 | S-TMR | | | | | | | | | | | | | | | | | | | | | | | |
| 3 | HOLD | | | | | | | | | | | | | | | | | | | | | | | |
| 4 | RESET | | | | | | | | | | | | | | | | | | | | | | | |
| 5 | N/C | | | | | | | | | | | | | | | | | | | | | | | |
| 6 | COM | | | | | | | | | | | | | | | | | | | | | | | |
| 7 | BANK4 | | | | | | | | | | | | | | | | | | | | | | | |
| 8 | BANK2 | | | | | | | | | | | | | | | | | | | | | | | |
| 9 | BANK1 | | | | | | | | | | | | | | | | | | | | | | | |
| 10 | COM | | | | | | | | | | | | | | | | | | | | | | | |

Derating Curve for Sensor Power Supply (Reference Values)

For 12V

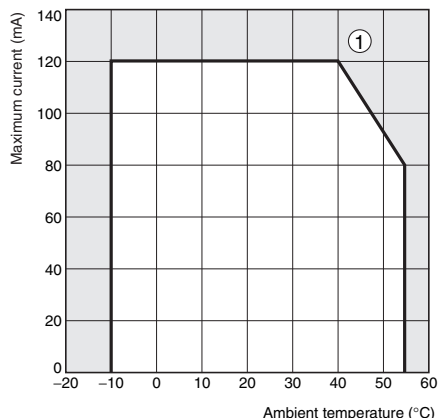

Note: 1. The above values were obtained under test conditions with the standard mounting. The derating curve will vary with the mounting conditions, so be sure to adjust accordingly.

2. Internal components may be deteriorated or damaged. Do not use the Digital Indicator outside of the derating range (i.e., do not use it in the area labeled ①, above).

Internal Block Diagram

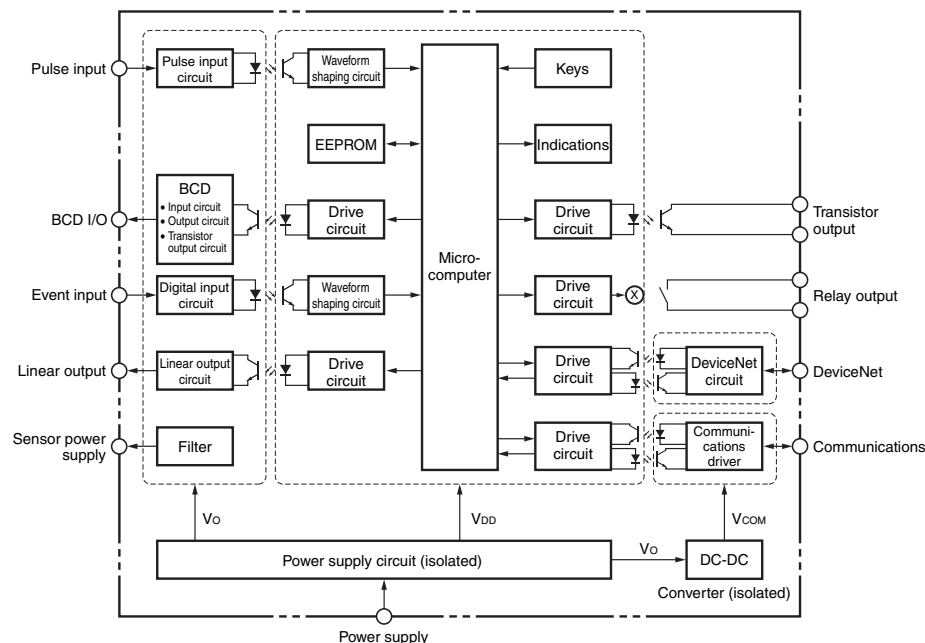

BCD Output Timing Chart

A REQUEST signal from a Programmable Controller or other external device is required to read BCD data.

Single Sampling Data Output

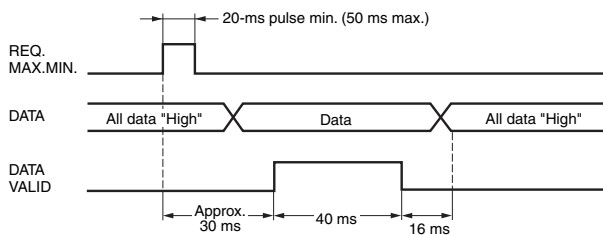

The data is set in approximately 30 ms from the rising edge of the REQUEST signal and the DATA VALID signal is output. When reading the data from a Programmable Controller, start reading the data when the DATA VALID signal turns ON. The DATA VALID signal will turn OFF 40 ms later, and the data will turn OFF 16 ms after that.

- The K3HB BCD output model has an open collector output, so wired OR connection is possible

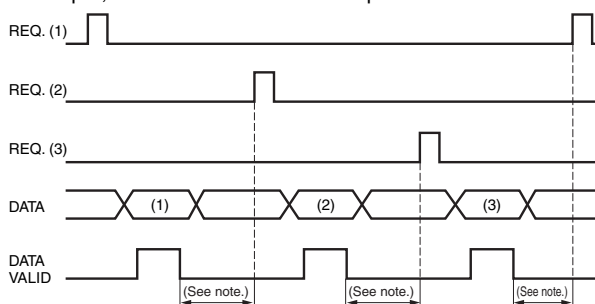
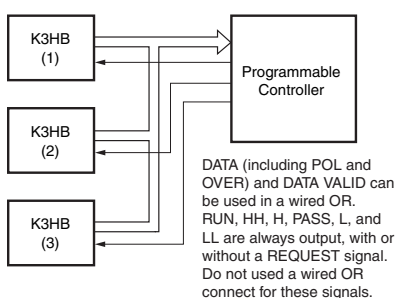

Note: Leave 20 ms min. between DATA VALID turning OFF and the REQUEST signal.

Continuous Data Output

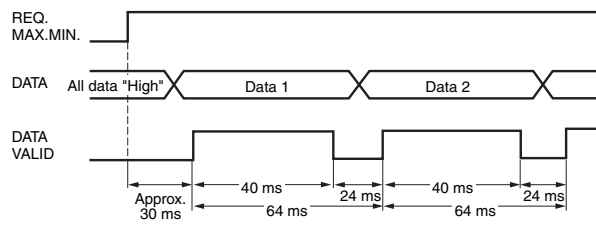

Measurement data is output every 64 ms while the REQUEST signal remains ON.

Note: If HOLD is executed when switching between data 1 and data 2, either data 1 or data 2 is output depending on the timing of the hold signal. The data will not go LOW.

Programmable Controller Connection Example

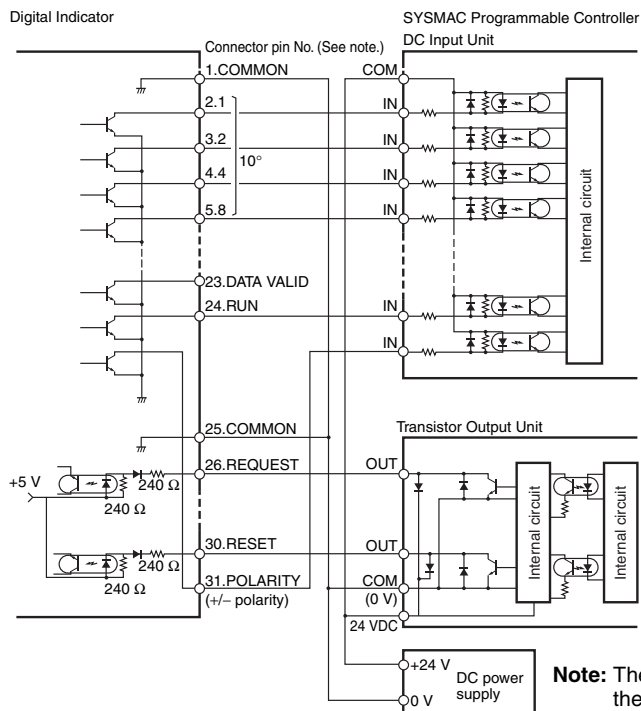

Display Unit Connection Example

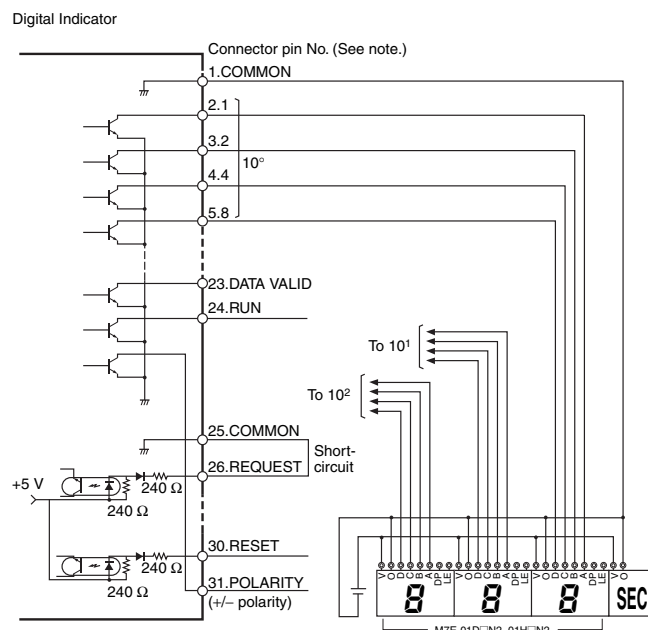

Note: The BCD output connector pin number is the D-sub connector pin number when the BCD Output Cable (sold separately) is connected. This number differs from the pin number for the Digital Indicator narrow pitch connector (manufactured by Honda Tsushin Kogyo Co., Ltd.).

Refer to the following User's Manual for application precautions and other information required when using the Digital Indicator:
 K3HB-R/P/C Digital Indicator User's Manual (Cat. No. N136)
 The manual can be downloaded from the following site in PDF format: OMRON Industrial Web <http://www.fa.omron.co.jp>

Component Names and Functions

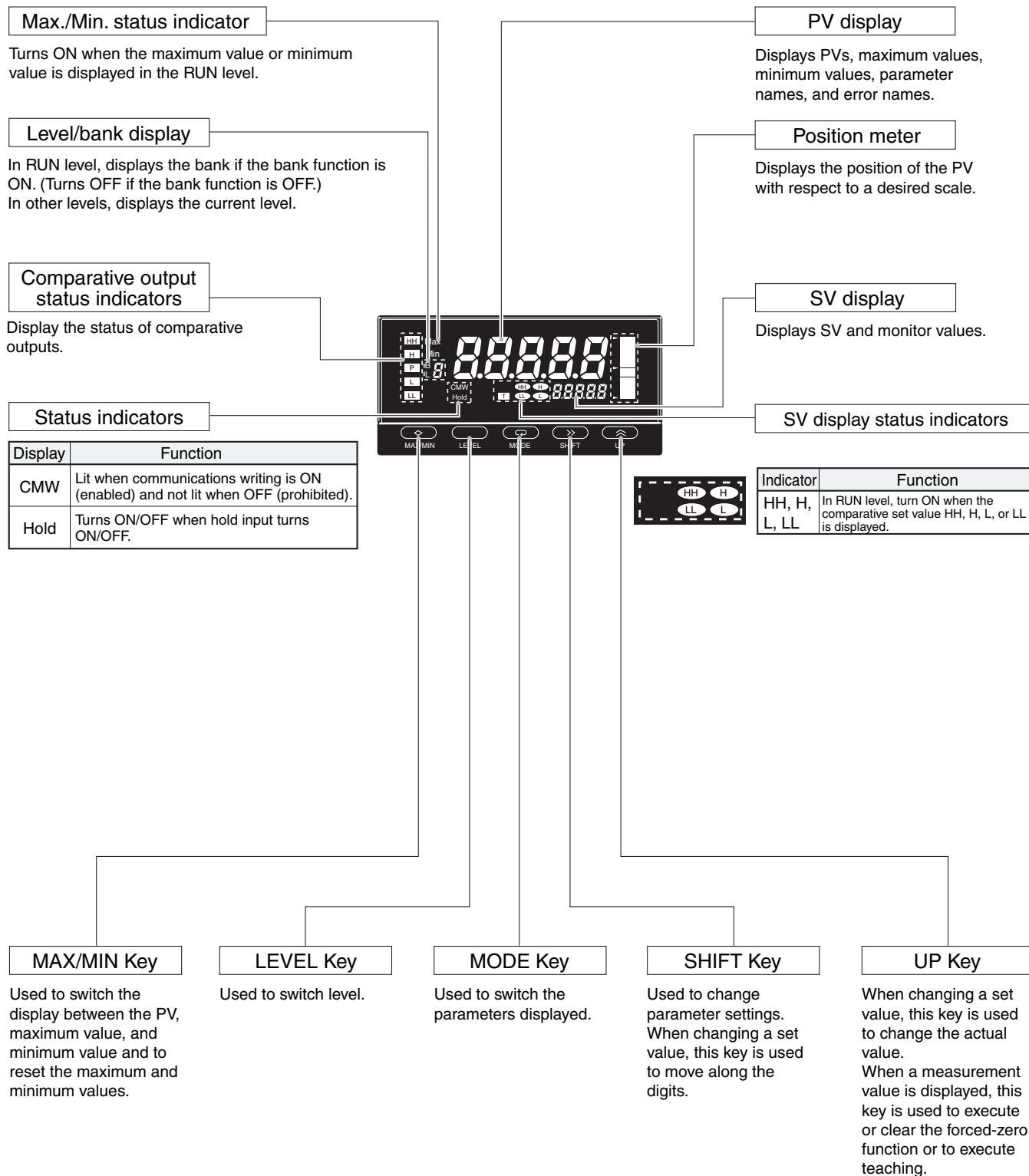

■ Dimensions

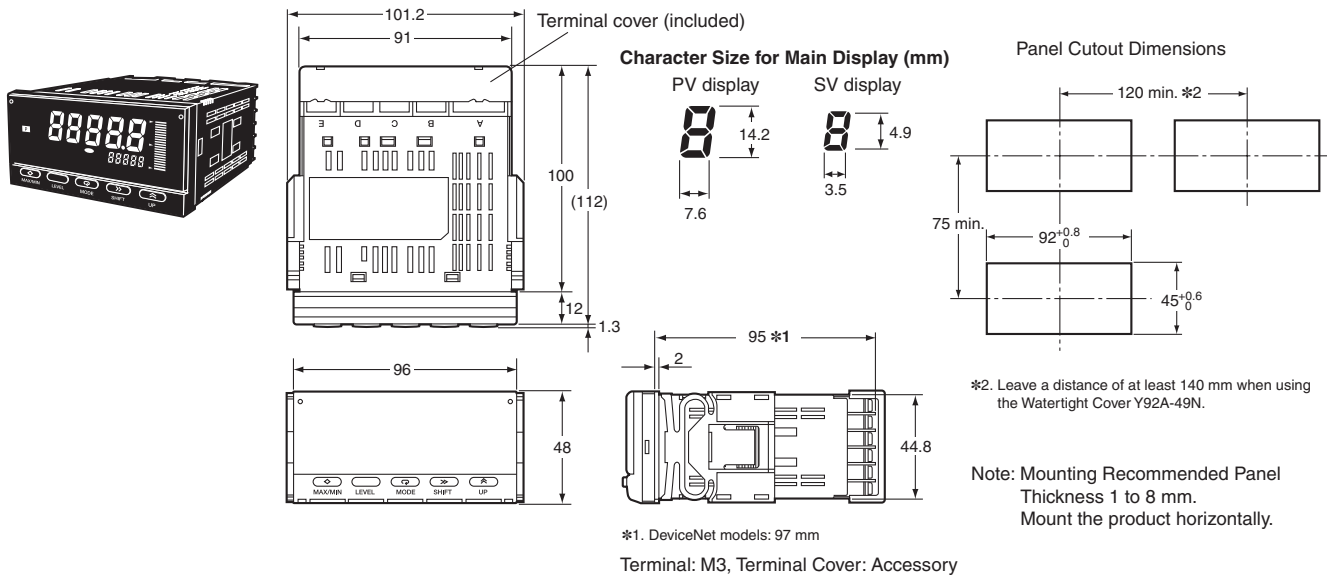

Wiring Precautions

- For terminal blocks, use the crimp terminals suitable for M3 screws.
- Tighten the terminal screws to the recommended tightening torque of approx. 0.5 N·m.
- To prevent inductive noise, separate the wiring for signal lines from that for power lines.

Wiring

- Use the crimp terminals suitable for M3 screws shown below.

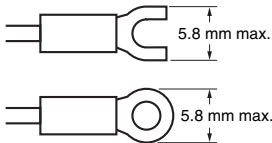

Unit Stickers (included)

- No unit stickers are attached to the Digital Indicator.
- Select the appropriate units from the unit sticker sheets provided.

| | | | | | | | |
|-------|-------|-----|----|-----|----|----------------|---|
| V | A | V | A | % | J | Pa | Ω |
| s | / | N | m | W | °C | m ³ | k |
| °F | g | min | mm | rpm | | | |
| VA | mV | mA | Hz | | | | |
| m/min | OMRON | | | | | | |
| OUT | OUT | | | | | | |

Note: For measurements for commercial purposes, be sure to use the unit required by any applicable laws or regulations.

Mounting Method

1. Insert the K3HB into the mounting cutout in the panel.
2. Insert watertight packing around the Unit to make the mounting watertight.

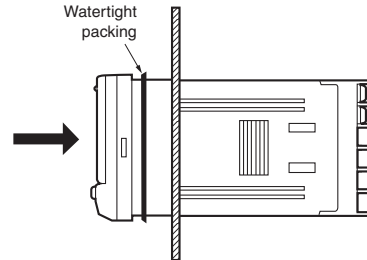

3. Insert the fixture into the grooves on the left and right sides of the rear case and push until it reaches the panel and is fixed in place.

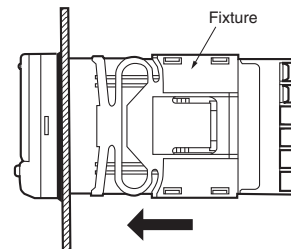

LCD Field of Vision

The K3HB is designed to have the best visibility at the angles shown in the following diagram.

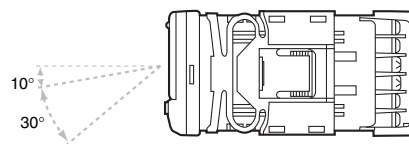

Watertight Cover

Y92A-49N

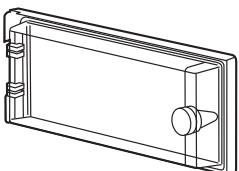

Rubber Packing

K32-P1

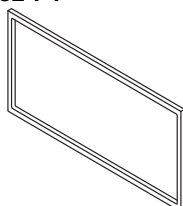

If the rubber packing is lost or damaged, it can be ordered using the following model number: K32-P1.

(Depending on the operating environment, deterioration, contraction, or hardening of the rubber packing may occur and so, in order to ensure the level of waterproofing specified in NEMA4, periodic replacement is recommended.)

Note: Rubber packing is provided with the Controller.

Main Functions

■ Main Functions and Features

Measurement

Function **FUN**

The K3HB-R has the following six functions for receiving and displaying input pulses.

F1: Rotation (rpm)/circumferential speed

F2: Absolute ratio

F3: Error ratio

F4: Rotational difference

F5: Flow rate ratio

F6: Passing time

The K3HB-P has the following six functions for receiving and displaying input pulses.

F1: Passing speed

F2: Cycle

F3: Time difference

F4: Time band

F5: Measuring length

F6: Interval

The K3HB-C has the following three functions for receiving and displaying input pulses.

F1: Individual inputs

F2: Phase differential inputs

F3: Pulse counting input

Filters

Input Types **IN-TR, IN-TB, IN-TR**

Specify the types of sensor connected to input A and input B.

Key Operations

Key Protection

Key protection restricts level or parameter changes using the keys to prevent unintentional key operations and malfunctions.

Outputs

Comparative Output Pattern **OUT-P**

Standard, zone, and level comparative output patterns can be selected for comparative outputs.

Output Refresh Stop **OUT-SP**

Holds the output status when a comparative result output other than PASS turns ON.

PASS Output Change **PASS**

Comparative results other than PASS can be output from the PASS output terminal.

Output OFF Delay **OFF-d**

Delays turning OFF comparatives for a set period. This can be used to provide sufficient time to read the comparative output ON status when the comparative result changes at short intervals.

Shot Output **SHOT**

Turns ON the comparative output for a specific time.

Output Logic **OUT-n**

Reverses the output logic of comparative results.

Output Test **TEST**

Output operation can be checked without using actual input signals by using the keys to set a test measurement value.

Linear Outputs **LSEEL, LSEEW, LSEEH, LSEEL**

A current or voltage proportional to the change in the measurement value can be output.

Standby Sequence **STDBY**

The comparison outputs can be kept OFF until the measurement value enters the PASS range.

Display

Display Value Selection **dLSF**

The display value can be set to the present value, the maximum value, or the minimum value.

Display Color Selection **LSLOR**

The present value display color can be set to green or red. The color of the present value can also be switched according to the comparative output.

Display Refresh Period **dREF**

When the input changes rapidly, the display refresh period can be lengthened to control flickering and make the display easier to read.

Position Meter **PSS-t, PSS-H, PSS-L**

The present measurement value can be displayed as a position in relation to the scaling width on a 20-gradation position meter.

Prescale **P5Aū, P5AY, P5bū, P5bY**

The input signal can be converted and displayed as any value.

Comparative Set Value Display **Su.dSP**

Select whether or not to display the comparative value during operation.

Display auto-return **rEt**

Automatically returns the display to RUN level when there are no key operations (e.g., max./min. switching, bank settings using keys).

Other

Max./Min. Hold

Holds the maximum and minimum measurement values.

Bank Selection **bnP-L**

Switch between 8 comparative value banks using the keys on the front panel or external inputs. A set of set comparative values can be selected as a group.

Bank Copy **LSPY**

Any bank settings can be copied to all banks.

По вопросам продаж и поддержки обращайтесь:

Архангельск (8182)63-90-72
Астана +7(7172)727-132
Астрахань (8512)99-46-04
Барнаул (3852)73-04-60
Белгород (4722)40-23-64
Брянск (4832)59-03-52
Владивосток (423)249-28-31
Волгоград (844)278-03-48
Вологда (8172)26-41-59
Воронеж (473)204-51-73
Екатеринбург (343)384-55-89
Иваново (4932)77-34-06
Ижевск (3412)26-03-58
Иркутск (395) 279-98-46

Казань (843)206-01-48
Калининград (4012)72-03-81
Калуга (4842)92-23-67
Кемерово (3842)65-04-62
Киров (8332)68-02-04
Краснодар (861)203-40-90
Красноярск (391)204-63-61
Курск (4712)77-13-04
Липецк (4742)52-20-81
Магнитогорск (3519)55-03-13
Москва (495)268-04-70
Мурманск (8152)59-64-93
Набережные Челны (8552)20-53-41
Нижний Новгород (831)429-08-12

Новокузнецк (3843)20-46-81
Новосибирск (383)227-86-73
Омск (3812)21-46-40
Орел (4862)44-53-42
Оренбург (3532)37-68-04
Пенза (8412)22-31-16
Пермь (342)205-81-47
Ростов-на-Дону (863)308-18-15
Рязань (4912)46-61-64
Самара (846)206-03-16
Санкт-Петербург (812)309-46-40
Саратов (845)249-38-78
Севастополь (8692)22-31-93
Симферополь (3652)67-13-56

Смоленск (4812)29-41-54
Сочи (862)225-72-31
Ставрополь (8652)20-65-13
Сургут (3462)77-98-35
Тверь (4822)63-31-35
Томск (3822)98-41-53
Тула (4872)74-02-29
Тюмень (3452)66-21-18
Ульяновск (8422)24-23-59
Уфа (347)229-48-12
Хабаровск (4212)92-98-04
Челябинск (351)202-03-61
Череповец (8202)49-02-64
Ярославль (4852)69-52-93

Киргизия (996)312-96-26-47

Казахстан (772)734-952-31

Таджикистан (992)427-82-92-69