

Up/Down Counting Pulse Indicator K3HB-C

CSM_K3HB-C_DS_E_17_2

Measure High-speed Up/down Pulses with this Up/down Pulse Meter.



- Visual confirmation of judgement results through display colors that switch between red and green. *1
- Perfect for Measuring Rotary Encoder and ON/OFF Pulse Signals at High Speed
Cumulative pulse input is 50 kHz, quadrature pulse inputs are 25 kHz, and up/down pulse inputs are 30 kHz.

Note: No-voltage contacts of up to 30 Hz are supported.

- The count value can be converted to any value.
The length equivalent for any pulse can be set to any desired value. This is effective for feed amount and position monitor displays.

- DeviceNet models added to the series. *2

*1 Visual confirmation of judgement results is not supported on models that do not have an output or models that do not support DeviceNet.

You can change the display color by setting it, but you cannot switch it based on the judgement results.

*2 DeviceNet models have a depth of 97 mm.



For the most recent information on models that have been certified for safety standards, refer to your OMRON website.

Refer to *Safety Precautions for All Digital Panel Meters.*

Model Number Structure

Model Number Legend

Base Units and Optional Boards can be ordered individually or as sets.

Base Units

K3HB-C
1 5

- 1. Input Sensor Code**
NB: NPN input/voltage pulse input
- 5. Supply Voltage**
100-240 VAC: 100 to 240 VAC
24 VAC/VDC: 24 VAC/VDC

Optional Board

Sensor Power Supply/Output Boards

K33-
2

Relay/Transistor Output Boards

K34-
3

Event Input Boards

K35-
4

Base Units with Optional Boards

K3HB-C -
1 2 3 4 5

2. Sensor Power Supply/Output Type Code

- None: None
- CPA: Relay output (PASS: SPDT) + Sensor power supply (12 VDC±10%, 80 mA) (See note 1.)
- L1A: Linear current output (0 to 20 or 4 to 20 mA DC) + Sensor power supply (12 VDC±10%, 80 mA) (See note 2.)
- L2A: Linear voltage output (0 to 5, 1 to 5, or 0 to 10 VDC) + Sensor power supply (12 VDC±10%, 80 mA) (See note 2.)
- A: Sensor power supply (12 VDC ±10%, 80 mA)
- FLK1A: Communications (RS-232C) + Sensor power supply (12 VDC±10%, 80 mA) (See note 2.)
- FLK3A: Communications (RS-485) + Sensor power supply (12 VDC±10%, 80 mA) (See note 2.)

Note: 1. CPA can be combined with relay outputs only.

2. Only one of the following can be used by each Digital Indicator: RS-232C/RS-485 communications, a linear output, or DeviceNet communications.

3. Relay/Transistor Output Type Code

- None: None
 - C2: Relay contact (HH/H/LL/L: SPST-NO each)
 - T1: Transistor (NPN open collector: HH/H/PASS/L/LL)
 - T2: Transistor (PNP open collector: HH/H/PASS/L/LL)
 - BCD *:BCD output + transistor output (NPN open collector: HH/H/PASS/L/LL)
 - DRT: DeviceNet (See note 2.)
- * A Special BCD Output Cable (sold separately) is required.

4. Event Input Type Code

- None: None
 - 1: 5 inputs (M3 terminal block), NPN open collector
 - 2 *: 8 inputs (10-pin MIL connector), NPN open collector
 - 3: 5 inputs (M3 terminal block), PNP open collector
 - 4 *: 8 inputs (10-pin MIL connector), PNP open collector
- * There is no bank selection for "None" and "DeviceNet" types of "Transistor Output Type Code".

Note: The following combinations are not possible.

- Communications (FLK□A) + DeviceNet (DRT)
- Communications (FLK□A) + BCD output (BCD)
- Linear current/voltage (L□A) + DeviceNet (DRT)

Accessories (Sold Separately)

K32-DICN: Special Cable (for event inputs with 8-pin connector)

K32-BCD: Special BCD Output Cable

Watertight Cover

Model
Y92A-49N

Rubber Packing

Model
K32-P1

Note: Rubber packing is provided with the Controller.

Specifications

■ Ratings

Supply voltage		100 to 240 VAC, 24 VAC/VDC, DeviceNet power supply: 24 VDC
Allowable power supply voltage range		85% to 110% of the rated power supply voltage, DeviceNet power supply: 11 to 25 VDC
Power consumption (See note 1.)		100 to 240 VAC: 18 VA max. (max. load) 24 VAC/DC: 11 VA/7 W max. (max. load)
Current consumption		DeviceNet power supply: 50 mA max. (24 VDC)
Input		No-voltage contact, voltage pulse, open collector
External power supply		12 VDC±10% 80 mA
Event inputs	Hold input	NPN open collector or no-voltage contact signal
	Reset input	ON residual voltage: 2 V max. ON current at 0 Ω: 4 mA max.
	Bank input	Max. applied voltage: 30 VDC max. OFF leakage current: 0.1 mA max.
Output ratings (depends on the model)	Relay output	250 VAC, 30 VDC, 5 A (resistive load) Mechanical life expectancy: 5,000,000 operations, Electrical life expectancy: 100,000 operations
	Transistor output	Maximum load voltage: 24 VDC, Maximum load current: 50 mA, Leakage current: 100 μA max.
	Linear output	Linear output 0 to 20 mA DC, 4 to 20 mA DC: Load: 500 Ω max, Resolution: Approx. 10,000, Output error: ±0.5% FS Linear output 0 to 5 VDC, 1 to 5 VDC, 0 to 10 VDC: Load: 5 kΩ max, Resolution: Approx. 10,000, Output error: ±0.5% FS (1 V or less: ±0.15 V; no output for 0 V or less)
Display method		Negative LCD (backlit LED) display 7-segment digital display (Character height: PV: 14.2 mm (green/red); SV: 4.9 mm (green))
Main functions		Scaling function, measurement operation selection, output hysteresis, output OFF delay, output test, and power interruption memory (See note 2.), display value selection, display color selection, key protection, bank selection, display refresh period, maximum/minimum hold, reset
Ambient operating temperature		-10 to 55°C (with no icing or condensation)
Ambient operating humidity		25% to 85%
Storage temperature		-25 to 65°C (with no icing or condensation)
Altitude		2,000 m max.
Accessories		Watertight packing, 2 fixtures, terminal cover, unit stickers, instruction manual. DeviceNet models also include a DeviceNet connector (Hirose HR31-5.08P-5SC(01)) and crimp terminals (Hirose HR31-SC-121) (See note 3.)

Note: 1. DC power supply models require a control power supply capacity of approximately 1 A per Unit when power is turned ON. Particular attention is required when using two or more DC power supply models. The OMRON S8VS-series DC Power Supply Unit is recommended.

2. The five displayed digits are stored in memory.

3. For K3HB-series DeviceNet models, use only the DeviceNet Connector included with the product. The crimp terminals provided are for Thin Cables.

По вопросам продаж и поддержки обращайтесь:

Архангельск (8182)63-90-72
Астана +7(7172)727-132
Астрахань (8512)99-46-04
Барнаул (3852)73-04-60
Белгород (4722)40-23-64
Брянск (4832)59-03-52
Владивосток (423)249-28-31
Волгоград (844)278-03-48
Вологда (8172)26-41-59
Воронеж (473)204-51-73
Екатеринбург (343)384-55-89
Иваново (4932)77-34-06
Ижевск (3412)26-03-58
Иркутск (395) 279-98-46

Казань (843)206-01-48
Калининград (4012)72-03-81
Калуга (4842)92-23-67
Кемерово (3842)65-04-62
Киров (8332)68-02-04
Краснодар (861)203-40-90
Красноярск (391)204-63-61
Курск (4712)77-13-04
Липецк (4742)52-20-81
Магнитогорск (3519)55-03-13
Москва (495)268-04-70
Мурманск (8152)59-64-93
Набережные Челны (8552)20-53-41
Нижний Новгород (831)429-08-12

Новокузнецк (3843)20-46-81
Новосибирск (383)227-86-73
Омск (3812)21-46-40
Орел (4862)44-53-42
Оренбург (3532)37-68-04
Пенза (8412)22-31-16
Пермь (342)205-81-47
Ростов-на-Дону (863)308-18-15
Рязань (4912)46-61-64
Самара (846)206-03-16
Санкт-Петербург (812)309-46-40
Саратов (845)249-38-78
Севастополь (8692)22-31-93
Симферополь (3652)67-13-56

Смоленск (4812)29-41-54
Сочи (862)225-72-31
Ставрополь (8652)20-65-13
Сургут (3462)77-98-35
Тверь (4822)63-31-35
Томск (3822)98-41-53
Тула (4872)74-02-29
Тюмень (3452)66-21-18
Ульяновск (8422)24-23-59
Уфа (347)229-48-12
Хабаровск (4212)92-98-04
Челябинск (351)202-03-61
Череповец (8202)49-02-64
Ярославль (4852)69-52-93

Киргизия (996)312-96-26-47

Казахстан (772)734-952-31

Таджикистан (992)427-82-92-69

Эл. почта: orm@nt-rt.ru || Сайт: <http://omron.nt-rt.ru>

■ Characteristics

Display range	-19,999 to 99,999	
Measurement range	Functions F1, F2: ± 2 gigacounts Functions F3: 0 to 4 gigacounts	
Input signals	<ul style="list-style-type: none"> • Contact input (dry contact input) (30 Hz max. with ON/OFF pulse width of 15 ms min.) • No contact voltage pulse 	
	Mode	Input frequency range
	F1	0 to 30 kHz
	F2	0 to 25 kHz
	F3	0 to 50 kHz
	ON/OFF pulse width	ON voltage
	16 μ s min.	
	20 μ s min.	
	9 μ s min.	
	4.5 to 30 V	
	-30 to 2 V	
	10 k Ω	
• Open collector	Mode	Input frequency range
	F1	0 to 30 kHz
	F2	0 to 25 kHz
	F3	0 to 50 kHz
	ON/OFF pulse width	
		16 μ s min.
	20 μ s min.	
	9 μ s min.	
	Note: The Up/Down Counting Pulse Meter will malfunction if a pulse greater than the input frequency range is input. SYSERR may appear on the display.	
Connectable sensors	ON residual voltage: 3 V max. OFF leakage current: 1.5 mA max. Load current: Must have a switching capacity of 20 mA or higher. Must be able to properly switch load currents of 5 mA or less.	
Max. No. of display digits	5 (-19999 to 99999)	
Comparative output response time	1 ms max.: Transistor output; 10 ms max.: Relay contact output (time until the comparative output is made when there is a forced sudden change in the input signal from 15% to 95% or 95% to 15%)	
Linear output response time	10 ms max. (time until the final analog output value is reached when there is a forced sudden change in the input signal from 15% to 95% or 95% to 15%)	
Display error when using prescale	± 1 digit	
Insulation resistance	20 M Ω min. (at 500 VDC)	
Dielectric strength	2,300 VAC for 1 min between external terminals and case	
Noise immunity	100 to 240 VAC models: $\pm 1,500$ V at power supply terminals in normal or common mode (waveform with 1-ns rising edge and pulse width of 1 μ s/100 ns) 24 VAC/VDC models: $\pm 1,500$ V at power supply terminals in normal or common mode (waveform with 1-ns rising edge and pulse width of 1 μ s/100 ns)	
Vibration resistance	Frequency: 10 to 55 Hz; Acceleration: 50 m/s ² , 10 sweeps of 5 min each in X, Y, and Z directions	
Shock resistance	150 m/s ² (100 m/s ² for relay outputs) 3 times each in 3 axes, 6 directions	
Weight	Approx. 300 g (Base Unit only)	
Degree of protection	Front panel	Conforms to NEMA 4X for indoor use (equivalent to IP66)
	Rear case	IP20
	Terminals	IP00 + finger protection (VDE0106/100)
Memory protection	EEPROM (non-volatile memory) Number of rewrites: 100,000	
Applicable standards	UL61010-1, CSA C22.2 No. 61010-1-04 EN61010-1 (IEC61010-1): Pollution degree 2/Overvoltage category II EN61326-1	
EMC	EMI: EN61326-1 Industrial electromagnetic environment Electromagnetic radiation interference CISPR 11 Group 1, Class A Terminal interference voltage CISPR 11 Group 1, Class A EMS: EN61326-1 Industrial electromagnetic environment Electrostatic Discharge Immunity EN61000-4-2: 4 kV (contact), 8 kV (in air) Radiated Electromagnetic Field Immunity EN61000-4-3: 10 V/m sine wave amplitude modulation (80 MHz to 1 GHz, 1.4 to 2 GHz) Electrical Fast Transient/Burst Noise Immunity EN61000-4-4: 2 kV (power line), 1 kV (I/O signal line) Surge Immunity EN61000-4-5: 1 kV with line (power line), 2 kV with ground (power line) Conducted Disturbance Immunity EN61000-4-6: 3 V (0.15 to 80 MHz) Power Frequency Magnetic Immunity EN61000-4-8: 30 A/m (50 Hz) continuous time Voltage Dips and Interruptions Immunity EN61000-4-11: 0.5 cycle, 0°/180°, 100% (rated voltage)	

Operation

■ Functions (Operating Modes)

F1 to F3

Function name	Function No.
Individual inputs	F1
Phase differential inputs	F2
Pulse counting input	F3

Function	Operation	Operation image (application)
F1 Individual inputs	<p>Counts input A as incremental pulses and input B as decremental pulses. The count is incremented on the rising edge of input A and decremented on the rising edge of input B. If both inputs rise at the same time, the count is not changed. The count is incremented when input B is later than input A and decremented when input B is earlier than input A.</p>	<p>Counting the number of people entering an area</p>
F2 Phase differential inputs	<p>This function is normally used when connected to an incremental rotary encoder. The count is incremented on the falling edge of input B when input A is OFF. The count is decremented on the rising edge of input B when input A is OFF.</p>	<p>Detecting position and speed on a semiconductor wafer conveyor line</p>
F3 Pulse counting input	<p>Counted on the rising edge of input A</p>	<p>Counting the number of workpieces</p>

Note: 1. Meaning of H and L in Display

Symbol	Input method	No-voltage input
H		Short-circuit
L		Open

2. Requires at least half the minimum signal width. If there is less than half, a ± 1 count error may occur.

Input Type Setting

	NO: Voltage pulse high	NC: Voltage pulse low
No-contact or voltage pulse input	00	01
Contact	10	11

■ What Is Prescaling?

Prescaling converts the count value to any numeric value.

To display $\square\square\square\square.\square$ mm in a system that outputs 250 pulses for a 0.5-m feed,

the length per pulse = $500 \text{ mm} (0.5 \text{ m}) \div 250 = 2$.

1. The prescale value for the K3HB-C is set using the mantissa X \times exponent Y,

so the prescale value = 2.0000×10^0 ,

X = 2.000, and Y = 00.

2. Next, set the decimal point position for one digit to the right of the decimal point: $\square\square\square\square.\square$

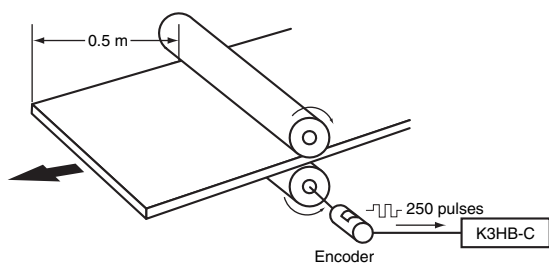

Common Specifications

Event Input Ratings

K3HB-P/-C	HOLD, RESET, BANK1, BANK2, BANK4
Contact	ON: 1 k Ω max., OFF: 100 k Ω min.
No-contact	ON residual voltage: 2 V max. OFF leakage current: 0.1 mA max. Load current: 4 mA max. Maximum applied voltage: 30 VDC max.

Output Ratings

Contact Output

Item	Resistive loads (250 VAC, $\cos\phi=1$; 30 VDC, L/R=0 ms)	Inductive loads (250 VAC, closed circuit, $\cos\phi=0.4$; 30 VDC, L/R=7 ms)
Rated load	5 A at 250 VAC 5 A at 30 VDC	1 A at 250 VAC 1 A at 30 VDC
Rated through current	5 A	
Mechanical life expectancy	5,000,000 operations	
Electrical life expectancy	100,000 operations	

Transistor Outputs

Maximum load voltage	24 VDC
Maximum load current	50 mA
Leakage current	100 μ A max.

Linear Output

Item	Outputs	0 to 20 mA	4 to 20 mA	0 to 5 V	1 to 5 V	0 to 10 V
Allowable load impedance		500 Ω max.		5 k Ω min.		
Resolution		Approx. 10,000				
Output error		$\pm 0.5\%$ FS		$\pm 0.5\%$ FS (± 0.15 V for 1 V or less and no output for 0 V)		

Serial Communications Output

Item	Type	RS-232C, RS-485
Communications method	Half duplex	
Synchronization method	Start-stop synchronization (asynchronous)	
Baud rate	9600/19200/38400 bps	
Transmission code	ASCII	
Data length	7 bits or 8 bits	
Stop bit length	2 bits or 1 bit	
Error detection	Vertical parity and FCS	
Parity check	Odd, even	

BCD Output I/O Ratings

(Input Signal Logic: Negative)

I/O signal name	Item	Rating
Inputs	REQUEST	Input signal
	CCOMPEN-	Input current for no-voltage input
	SATION	Signal level
	RESET	ON voltage
		OFF voltage
Outputs	DATA	Maximum load voltage
	POLARITY	Maximum load current
	OVER	Leakage current
	DATA VALID	
	RUN	
	OUT1	Maximum load voltage
	OUT2	Maximum load current
OUT3		
OUT4		
OUT5	Leakage current	

Refer to the *K3HB Communications User's Manual* (Cat. No. N129) for details on serial and DeviceNet communications.

DeviceNet Communications

Communications protocol		Conforms to DeviceNet																		
Supported communications	Remote I/O communications	Master-Slave connection (polling, bit-strobe, COS, cyclic) Conforms to DeviceNet communications standards.																		
	I/O allocations	Allocate any I/O data using the Configurator. Allocate any data, such as DeviceNet-specific parameters and variable area for Digital Indicators. Input area: 2 blocks, 60 words max. Output area: 1 block, 29 words max. (The first word in the area is always allocated for the Output Execution Enabled Flags.)																		
	Message communications	Explicit message communications CompoWay/F communications commands can be executed (using explicit message communications)																		
Connection methods		Combination of multi-drop and T-branch connections (for trunk and drop lines)																		
Baud rate		DeviceNet: 500, 250, or 125 Kbps (automatic follow-up)																		
Communications media		Special 5-wire cable (2 signal lines, 2 power supply lines, 1 shield line)																		
Communications distance		<table border="1"> <thead> <tr> <th>Baud rate</th> <th>Network length (max.)</th> <th>Drop line length (max.)</th> <th>Total drop line length (max.)</th> </tr> </thead> <tbody> <tr> <td>500 Kbps</td> <td>100 m max. (100 m max.)</td> <td>6 m max.</td> <td>39 m max.</td> </tr> <tr> <td>250 Kbps</td> <td>100 m max. (250 m max.)</td> <td>6 m max.</td> <td>78 m max.</td> </tr> <tr> <td>125 Kbps</td> <td>100 m max. (500 m max.)</td> <td>6 m max.</td> <td>156 m max.</td> </tr> </tbody> </table> <p>The values in parentheses are for Thick Cable.</p>			Baud rate	Network length (max.)	Drop line length (max.)	Total drop line length (max.)	500 Kbps	100 m max. (100 m max.)	6 m max.	39 m max.	250 Kbps	100 m max. (250 m max.)	6 m max.	78 m max.	125 Kbps	100 m max. (500 m max.)	6 m max.	156 m max.
Baud rate	Network length (max.)	Drop line length (max.)	Total drop line length (max.)																	
500 Kbps	100 m max. (100 m max.)	6 m max.	39 m max.																	
250 Kbps	100 m max. (250 m max.)	6 m max.	78 m max.																	
125 Kbps	100 m max. (500 m max.)	6 m max.	156 m max.																	
Communications power supply		24-VDC DeviceNet power supply																		
Allowable voltage fluctuation range		11 to 25-VDC DeviceNet power supply																		
Current consumption		50 mA max. (24 VDC)																		
Maximum number of nodes		64 (DeviceNet Configurator is counted as one node when connected.)																		
Maximum number of slaves		63																		
Error control checks		CRC errors																		
DeviceNet power supply		Supplied from DeviceNet communications connector																		

Connections

External Connection Diagrams

Terminal Arrangements

Note: Refer to *Internal Block Diagram* on page 10 for information on isolation.

A Operating Power Supply

100 to 240 VAC
24 VAC/VDC

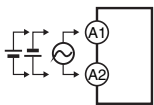

*Check the required power supply type.

B Sensor Power Supply/Output

Sensor power supply + PASS output

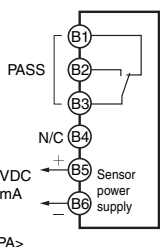

<CPA>

Sensor power supply + linear output

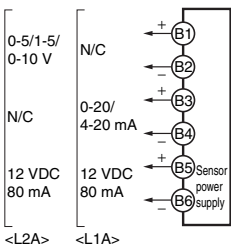

<L2A> <L1A>

Sensor power supply

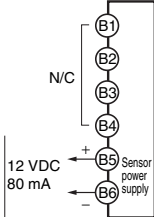

<A>

Sensor power supply + communications

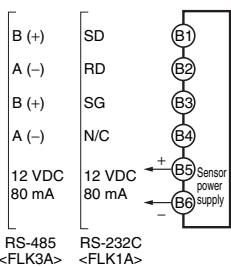

RS-485 <FLK3A> RS-232C <FLK1A>

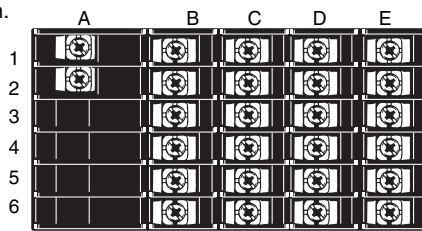

C Relays, Transistors, BCD and DeviceNet

Relay Outputs <C1>

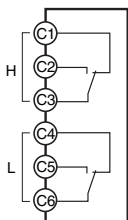

Relay Outputs <C2>

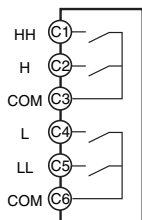

Transistor Outputs <T1> <T2>

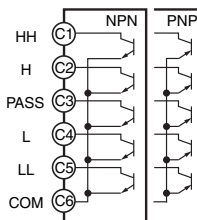

DeviceNet Connector (Included) <DRT>

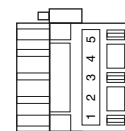

- 1: V- (Power supply cable: Black)
 - 2: CAN L (Communications cable: Blue)
 - 3: Shield
 - 4: CAN H (Communications cable: White)
 - 5: V+ (Power supply cable: Red)
- Applicable Connector:
HR31-5.08P-5SC (01)
(HIROSE ELECTRIC CO., LTD.)
* Attach the provided crimp terminals.

BCD (NPN Open Collector): <BCD>

- Applicable Connector (Sold separately)
HDR-E50MAG1 (HONDA TSUSHIN KOGYO CO., LTD.)
- Special Cable (Sold separately)
K32-BCD (OMRON)
- (HDR-E50MAG1 with 0.3-m cable)

The BCD COMMON is shared.
The pins indicated in the above diagram as blank (white) boxes have been removed.

Only one of the following can be used for each Digital Indicator: communications, BCD, or DeviceNet.

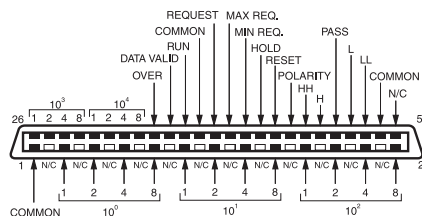

Contact Outputs

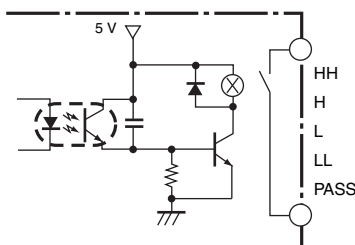

Transistor Outputs (NPN Open Collector)

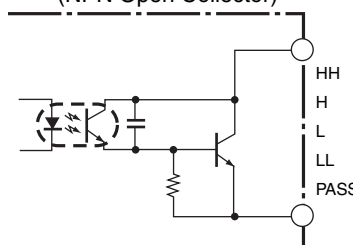

Safety Standards Conformance

- Always use a EN/IEC-compliant power supply with reinforced insulation or double insulation for the DeviceNet power supply.
- The product must be used indoors for the above applicable standards to apply.

E Pulse Inputs

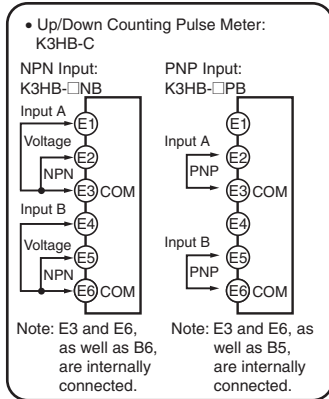

NPN Input Model
• NPN input section

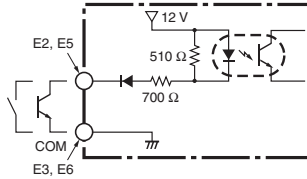

Connectable Sensors	ON residual voltage: 3 V
	OFF leakage current: 1.5 mA max.

• Voltage pulse input section

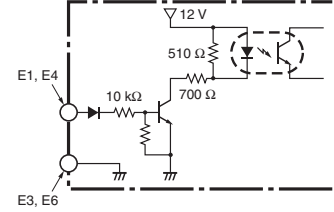

Connectable Sensors	ON voltage: 4.5 to 30 V
	OFF voltage: -30 to 2 V

Note: A 2-wire DC sensor can also be connected. Check the ratings and characteristics tables, however, for the connection conditions.

D Event Inputs

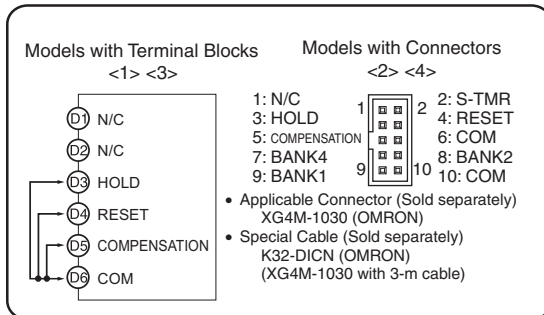

Note: The actual terminal label abbreviates "COMPENSATION" to "CMP."

- Use terminal pin D6 as the common terminal.
 - Use NPN open collector or no-voltage contacts for event input.
- PNP types are also available.

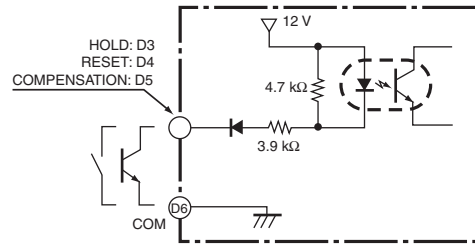

BCD Output Cable

Model	Shape	Pin arrangement
K32-BCD	<p>Cover: HDR-E50LPA5 (manufactured by Honda Tsushin Co., Ltd.) Connector: HDR-E50MAG1 (manufactured by Honda Tsushin Co., Ltd.)</p> <p>D-sub connector (37-pin female) Cover: 17JE-37H-1A (manufactured by DDK) Connector: Equivalent to 17JE-13370-02 (manufactured by DDK) Stud: 17L-002A (manufactured by DDK)</p>	

Note: The BCD Output Cable has a D-sub plug. Cover: 17JE-37H-1A (manufactured by DDK); Connector: equivalent to 17JE-23370-02 (D1) (manufactured by DDK)

Special Cable (for Event Inputs with 8-pin Connector)

Model	Appearance	Wiring																						
K32-DICN		<table border="1"> <thead> <tr> <th>Pin No.</th> <th>Signal name</th> </tr> </thead> <tbody> <tr><td>1</td><td>N/C</td></tr> <tr><td>2</td><td>S-TMR</td></tr> <tr><td>3</td><td>HOLD</td></tr> <tr><td>4</td><td>RESET</td></tr> <tr><td>5</td><td>N/C</td></tr> <tr><td>6</td><td>COM</td></tr> <tr><td>7</td><td>BANK4</td></tr> <tr><td>8</td><td>BANK2</td></tr> <tr><td>9</td><td>BANK1</td></tr> <tr><td>10</td><td>COM</td></tr> </tbody> </table>	Pin No.	Signal name	1	N/C	2	S-TMR	3	HOLD	4	RESET	5	N/C	6	COM	7	BANK4	8	BANK2	9	BANK1	10	COM
Pin No.	Signal name																							
1	N/C																							
2	S-TMR																							
3	HOLD																							
4	RESET																							
5	N/C																							
6	COM																							
7	BANK4																							
8	BANK2																							
9	BANK1																							
10	COM																							

Derating Curve for Sensor Power Supply (Reference Values)

For 12V

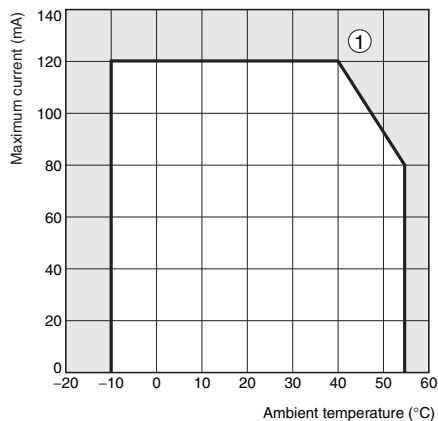

Note: 1. The above values were obtained under test conditions with the standard mounting. The derating curve will vary with the mounting conditions, so be sure to adjust accordingly.

2. Internal components may be deteriorated or damaged. Do not use the Digital Indicator outside of the derating range (i.e., do not use it in the area labeled ①, above).

Internal Block Diagram

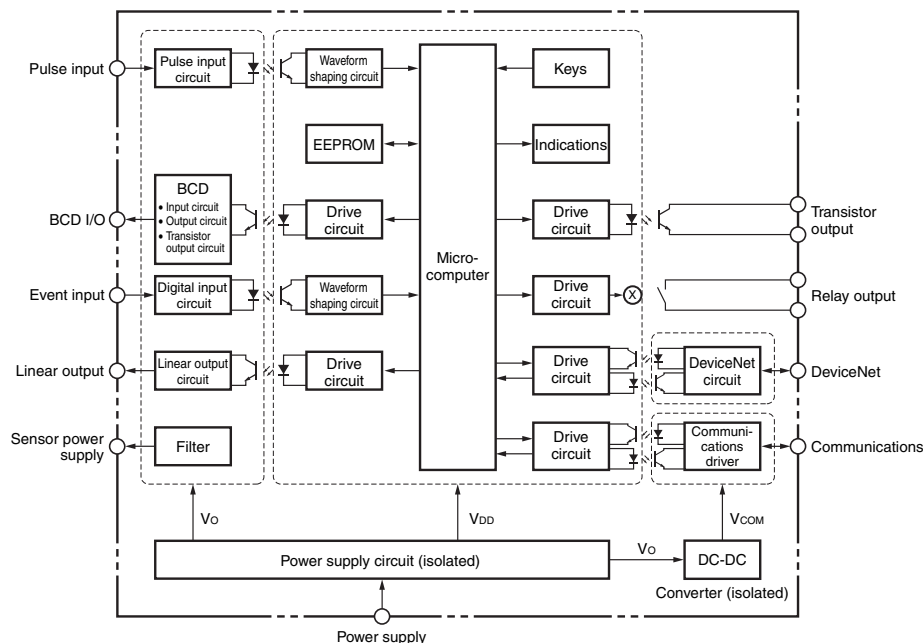

BCD Output Timing Chart

A REQUEST signal from a Programmable Controller or other external device is required to read BCD data.

Single Sampling Data Output

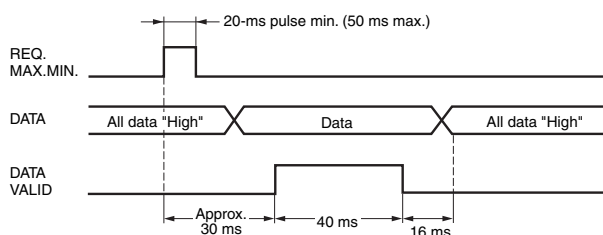

The data is set in approximately 30 ms from the rising edge of the REQUEST signal and the DATA VALID signal is output. When reading the data from a Programmable Controller, start reading the data when the DATA VALID signal turns ON. The DATA VALID signal will turn OFF 40 ms later, and the data will turn OFF 16 ms after that.

- The K3HB BCD output model has an open collector output, so wired OR connection is possible

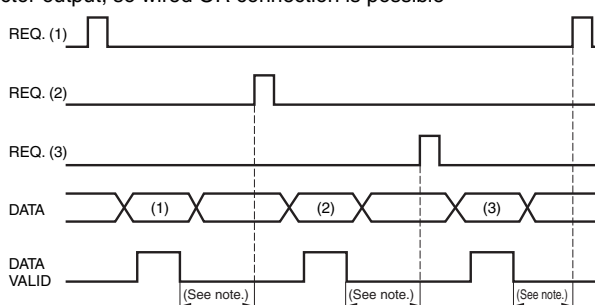
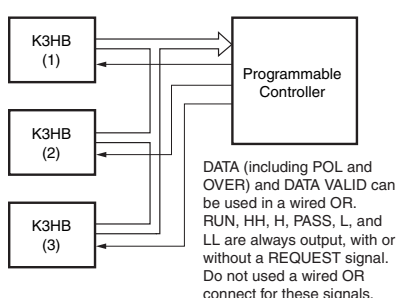

Note: Leave 20 ms min. between DATA VALID turning OFF and the REQUEST signal.

Continuous Data Output

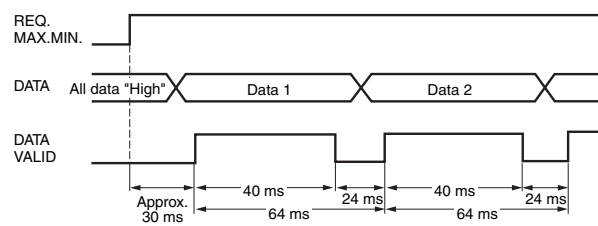

Measurement data is output every 64 ms while the REQUEST signal remains ON.

Note: If HOLD is executed when switching between data 1 and data 2, either data 1 or data 2 is output depending on the timing of the hold signal. The data will not go LOW.

Programmable Controller Connection Example

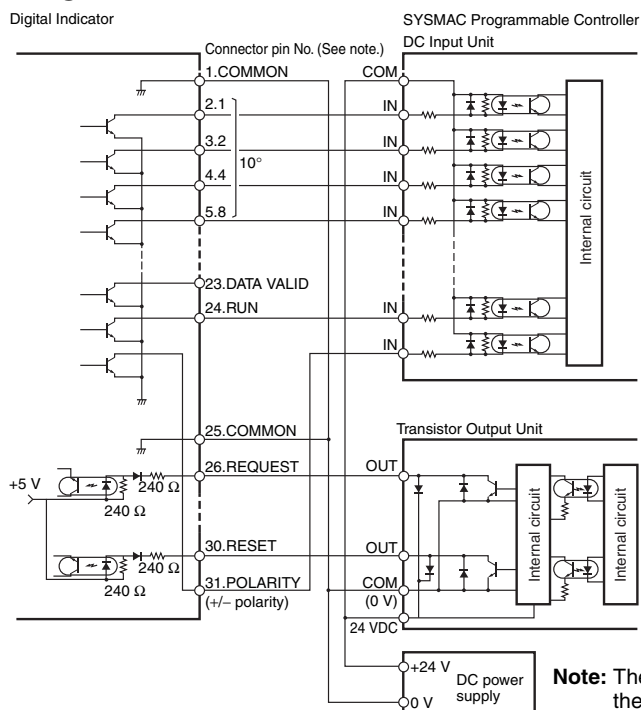

Display Unit Connection Example

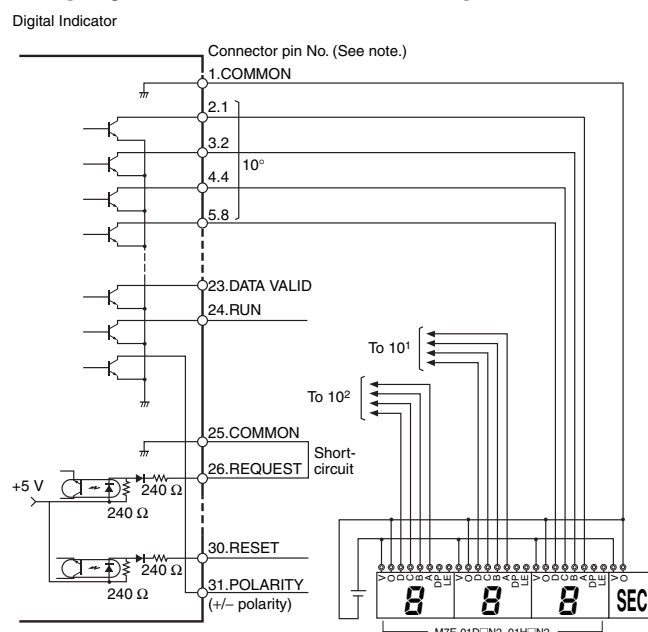

Note: The BCD output connector pin number is the D-sub connector pin number when the BCD Output Cable (sold separately) is connected. This number differs from the pin number for the Digital Indicator narrow pitch connector (manufactured by Honda Tsushin Kogyo Co., Ltd.).

Refer to the following User's Manual for application precautions and other information required when using the Digital Indicator:
 K3HB-R/P/C Digital Indicator User's Manual (Cat. No. N136)
 The manual can be downloaded from the following site in PDF format: OMRON Industrial Web <http://www.fa.omron.co.jp>

Component Names and Functions

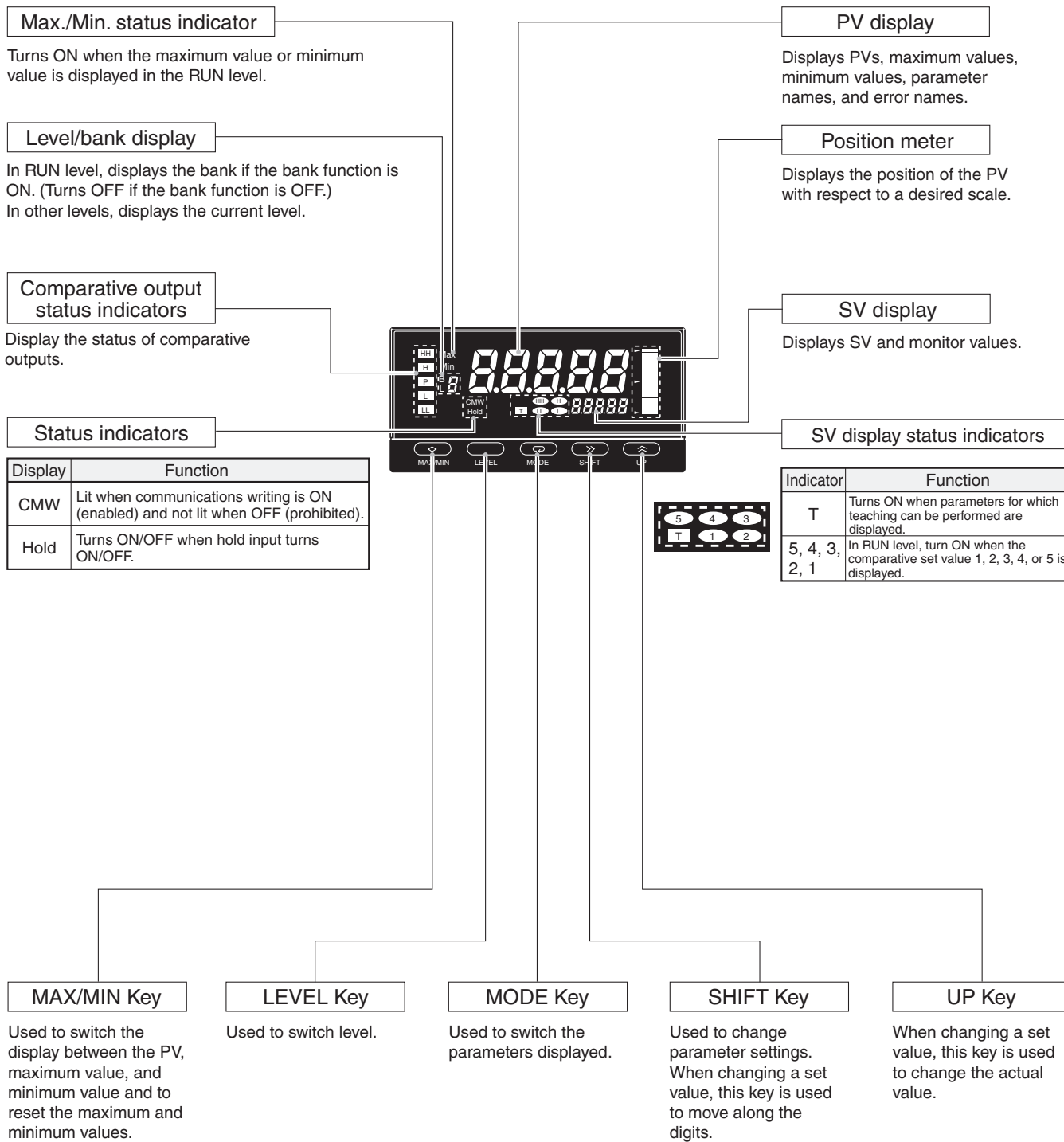

■ Dimensions

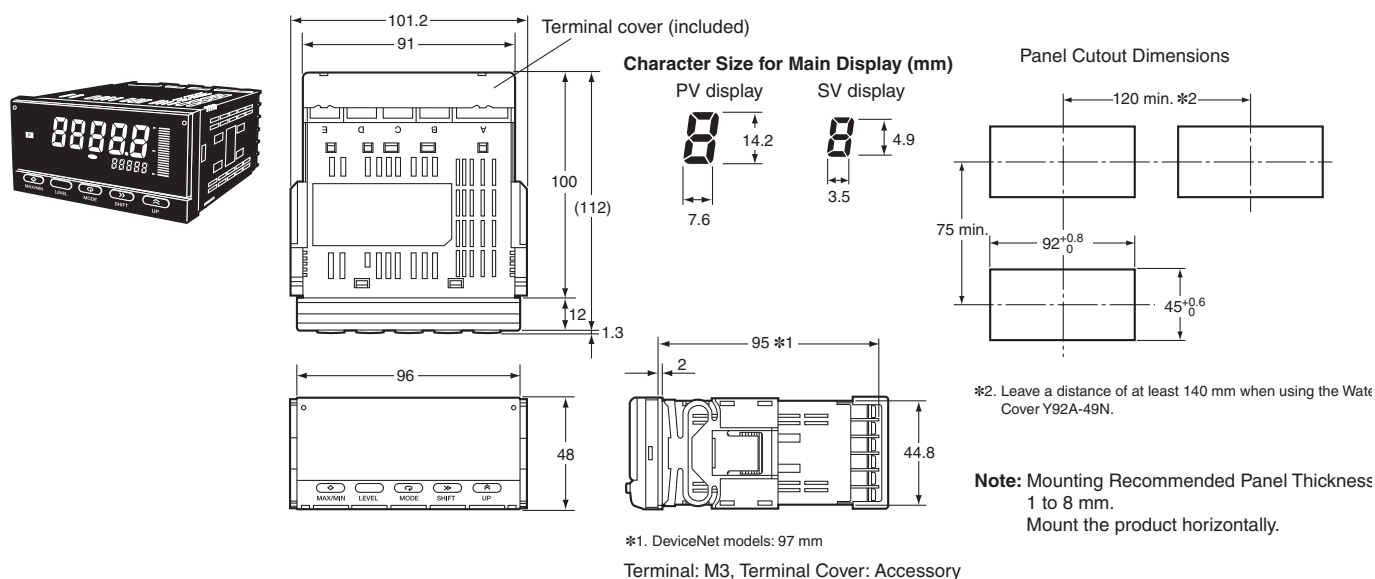

Wiring Precautions

- For terminal blocks, use the crimp terminals suitable for M3 screws.
- Tighten the terminal screws to the recommended tightening torque of approx. 0.5 N·m.
- To prevent inductive noise, separate the wiring for signal lines from that for power lines.

Wiring

- Use the crimp terminals suitable for M3 screws shown below.

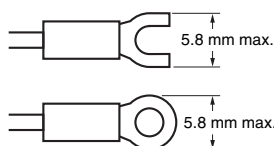

Unit Stickers (included)

- No unit stickers are attached to the Digital Indicator.
- Select the appropriate units from the unit sticker sheets provided.

V	A	V	A	%	J	Pa	Ω
s	/	N	m	W	°C	m ³	k
°F	g	min	mm	rpm			
VA	mV	mA	Hz				
m/min	OMRON						
OUT	OUT						

Note: For measurements for commercial purposes, be sure to use the unit required by any applicable laws or regulations.

Mounting Method

1. Insert the K3HB into the mounting cutout in the panel.
2. Insert watertight packing around the Unit to make the mounting watertight.

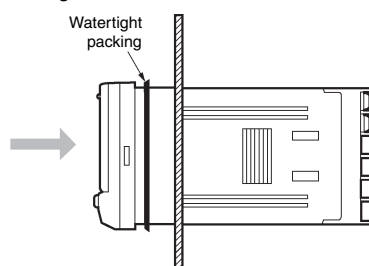

3. Insert the fixture into the grooves on the left and right sides of the rear case and push until it reaches the panel and is fixed in place.

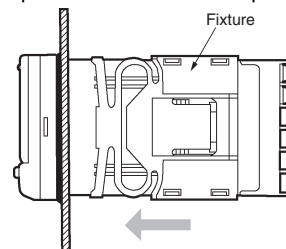

LCD Field of Vision

The K3HB is designed to have the best visibility at the angles shown in the following diagram.

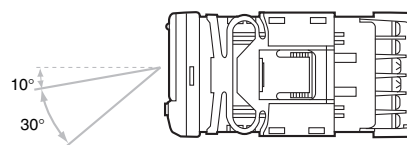

Watertight Cover

Y92A-49N

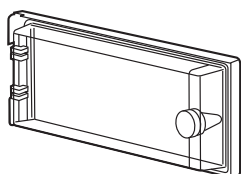

Rubber Packing

K32-P1

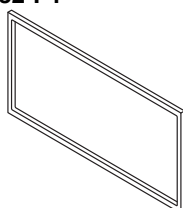

If the rubber packing is lost or damaged, it can be ordered using the following model number: K32-P1.

(Depending on the operating environment, deterioration, contraction, or hardening of the rubber packing may occur and so, in order to ensure the level of waterproofing specified in NEMA4, periodic replacement is recommended.)

Note: Rubber packing is provided with the Controller.

Main Functions

■ Main Functions and Features

Measurement

Function **FUN**

The K3HB-R has the following six functions for receiving and displaying input pulses.

F1: Rotation (rpm)/circumferential speed

F2: Absolute ratio

F3: Error ratio

F4: Rotational difference

F5: Flow rate ratio

F6: Passing time

The K3HB-P has the following six functions for receiving and displaying input pulses.

F1: Passing speed

F2: Cycle

F3: Time difference

F4: Time band

F5: Measuring length

F6: Interval

The K3HB-C has the following three functions for receiving and displaying input pulses.

F1: Individual inputs

F2: Phase differential inputs

F3: Pulse counting input

Filters

Input Types **IN-TR, IN-TB, IN-TR**

Specify the types of sensor connected to input A and input B.

Compensation

Compensation **COMP, COMP-P**

The display can be changed to a preset compensation value using the compensation input.

Key Operations

Teaching

The present measurement value can be used as a scaling value.

Key Protection

Key protection restricts level or parameter changes using the keys to prevent unintentional key operations and malfunctions.

Outputs

Comparative Output Pattern **OUT-P**

Zone and level comparative output patterns can be selected for comparative outputs.

Output OFF Delay **OFF-d**

Delays turning OFF comparatives for a set period. This can be used to provide sufficient time to read the comparative output ON status when the comparative result changes at short intervals.

Shot Output **SHOT**

Turns ON the comparative output for a specific time.

Output Logic **OUT-n**

Reverses the output logic of comparative results.

Output Test **TEST**

Output operation can be checked without using actual input signals by using the keys to set a test measurement value.

Linear Outputs **LSEEL, LSEEW, LSEEH, LSEEL**

A current or voltage proportional to the change in the measurement value can be output.

Standby Sequence **STDBY**

The comparison outputs can be kept OFF until the measurement value enters the PASS range.

Display

Display Value Selection *dLSF*

The display value can be set to the present value, the maximum value, or the minimum value.

Display Color Selection *LSLOR*

The present value display color can be set to green or red. The color of the present value can also be switched according to the comparative output.

Display Refresh Period *dREF*

When the input changes rapidly, the display refresh period can be lengthened to control flickering and make the display easier to read.

Position Meter *PSS-t, PSS-H, PSS-L*

The present measurement value can be displayed as a position in relation to the scaling width on a 20-gradation position meter.

Prescale *P5Aū, P5AY, P5bū, P5bY*

The input signal can be converted and displayed as any value.

Comparative Set Value Display *Su.dSP*

Select whether or not to display the comparative value during operation.

Display auto-return *rEt*

Automatically returns the display to RUN level when there are no key operations (e.g., max./min. switching, bank settings using keys).

Other

Bank Selection *bnP-Ł*

Switch between 8 comparative value banks using the keys on the front panel or external inputs. A set of set comparative values can be selected as a group.

Bank Copy *ŁOPY*

Any bank settings can be copied to all banks.

Interruption Memory *ñEñō*

The measured value can be recorded when the power supply is interrupted.

По вопросам продаж и поддержки обращайтесь:

Архангельск (8182)63-90-72
Астана +7(7172)727-132
Астрахань (8512)99-46-04
Барнаул (3852)73-04-60
Белгород (4722)40-23-64
Брянск (4832)59-03-52
Владивосток (423)249-28-31
Волгоград (844)278-03-48
Вологда (8172)26-41-59
Воронеж (473)204-51-73
Екатеринбург (343)384-55-89
Иваново (4932)77-34-06
Ижевск (3412)26-03-58
Иркутск (395) 279-98-46

Казань (843)206-01-48
Калининград (4012)72-03-81
Калуга (4842)92-23-67
Кемерово (3842)65-04-62
Киров (8332)68-02-04
Краснодар (861)203-40-90
Красноярск (391)204-63-61
Курск (4712)77-13-04
Липецк (4742)52-20-81
Магнитогорск (3519)55-03-13
Москва (495)268-04-70
Мурманск (8152)59-64-93
Набережные Челны (8552)20-53-41
Нижний Новгород (831)429-08-12

Новокузнецк (3843)20-46-81
Новосибирск (383)227-86-73
Омск (3812)21-46-40
Орел (4862)44-53-42
Оренбург (3532)37-68-04
Пермь (342)205-81-47
Ростов-на-Дону (863)308-18-15
Рязань (4912)46-61-64
Самара (846)206-03-16
Санкт-Петербург (812)309-46-40
Саратов (845)249-38-78
Севастополь (8692)22-31-93
Симферополь (3652)67-13-56

Смоленск (4812)29-41-54
Сочи (862)225-72-31
Ставрополь (8652)20-65-13
Сургут (3462)77-98-35
Тверь (4822)63-31-35
Томск (3822)98-41-53
Тула (4872)74-02-29
Тюмень (3452)66-21-18
Ульяновск (8422)24-23-59
Уфа (347)229-48-12
Хабаровск (4212)92-98-04
Челябинск (351)202-03-61
Череповец (8202)49-02-64
Ярославль (4852)69-52-93

Киргизия (996)312-96-26-47

Казахстан (772)734-952-31

Таджикистан (992)427-82-92-69

Эл. почта: orm@nt-rt.ru || Сайт: <http://omron.nt-rt.ru>