

E3S-CL

- High water, oil and detergent resistance
- Minimal black/white error for highest reliability detecting different colored objects (E3S-CL1)



Features

Eliminates Background Influences with a Hysteresis of Only 2% max. (E3S-CL1)

The hysteresis is the industry's minimum 2% max. (E3S-CL1). As a triangulation measuring is used, objects behind the setting distance cannot be detected. The sensor is insensitive to the influence of background objects of high reflectivity, and stable detects works on a conveyor from above. The hysteresis of the E3S-CL2 is 10% max. of the detecting distance (5% max. for white paper).



What Is Distance Setting? (Differences from other detecting system)

Distance-setting

Features	When the sensing object moves in direction A, the center position of the reflected light moves in direction B. This is received by the 2-split photodiode and the place where the incident levels are the same on the N and F sides is defined as the setting distance. The object is detected by the incident circuit processing only when N > F, and is not detected when N < F. Therefore, detection is stable without being influenced by the work type and background objects.
Structure	<p>N: Near F: Far</p>

Diffuse-reflective

Features	Since the level of the reflected light is judged for detection, the sensing distance varies with the color, material and/or size of the work. A malfunction may occur if there is any object of high reflectivity in the background.
Structure	

По вопросам продаж и поддержки обращайтесь:

Архангельск (8182)63-90-72
 Астана +7(7172)727-132
 Астрахань (8512)99-46-04
 Барнаул (3852)73-04-60
 Белгород (4722)40-23-64
 Брянск (4832)59-03-52
 Владивосток (423)249-28-31
 Волгоград (844)278-03-48
 Вологда (8172)26-41-59
 Воронеж (473)204-51-73
 Екатеринбург (343)384-55-89
 Иваново (4932)77-34-06
 Ижевск (3412)26-03-58
 Иркутск (395) 279-98-46

Казань (843)206-01-48
 Калининград (4012)72-03-81
 Калуга (4842)92-23-67
 Кемерово (3842)65-04-62
 Киров (8332)68-02-04
 Краснодар (861)203-40-90
 Красноярск (391)204-63-61
 Курск (4712)77-13-04
 Липецк (4742)52-20-81
 Магнитогорск (3519)55-03-13
 Москва (495)268-04-70
 Мурманск (8152)59-64-93
 Набережные Челны (8552)20-53-41
 Нижний Новгород (831)429-08-12

Новокузнецк (3843)20-46-81
 Новосибирск (383)227-86-73
 Омск (3812)21-46-40
 Орел (4862)44-53-42
 Оренбург (3532)37-68-04
 Пенза (8412)22-31-16
 Пермь (342)205-81-47
 Ростов-на-Дону (863)308-18-15
 Рязань (4912)46-61-64
 Самара (846)206-03-16
 Санкт-Петербург (812)309-46-40
 Саратов (845)249-38-78
 Севастополь (8692)22-31-93
 Симферополь (3652)67-13-56

Смоленск (4812)29-41-54
 Сочи (862)225-72-31
 Ставрополь (8652)20-65-13
 Сургут (3462)77-98-35
 Тверь (4822)63-31-35
 Томск (3822)98-41-53
 Тула (4872)74-02-29
 Тюмень (3452)66-21-18
 Ульяновск (8422)24-23-59
 Уфа (347)229-48-12
 Хабаровск (4212)92-98-04
 Челябинск (351)202-03-61
 Череповец (8202)49-02-64
 Ярославль (4852)69-52-93

Киргизия (996)312-96-26-47

Казахстан (772)734-952-31

Таджикистан (992)427-82-92-69

6-turn adjuster with indicator

- The 6-turn adjuster with indicator ensures ease of distance setting.
- Fine distance setting is possible.



Optical Technology of E3S-CL

By turning the distance setting adjuster (worm gear), the rotation of the gear moves the cam to change the incident angle of the whole incident block (lens and photodiode), setting the distance.

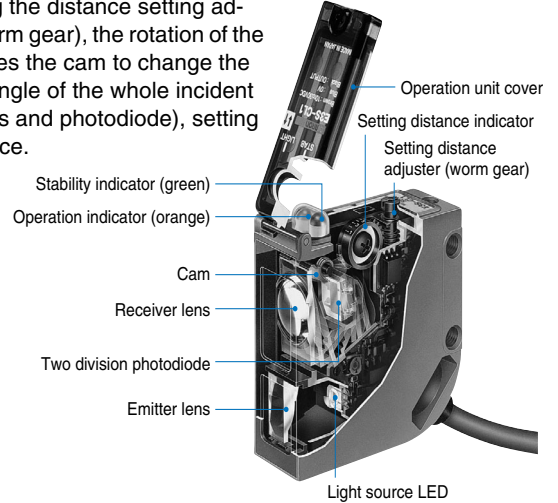

- NPN/PNP Output Selectable.
- Light-ON/Dark-ON is also switch selectable.

Conforms to Applicable EN/IEC Standards

- The sensors satisfy the electrical safety (IEC947-5-2), noise resistance (IEC947-5-2, IEC801-2/3/4) and noise radiation restrictions (EN500 81-2, EN55011) required for photoelectric sensors.

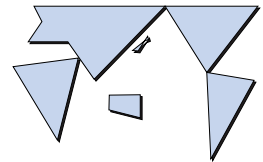

Application

E3S-CL1

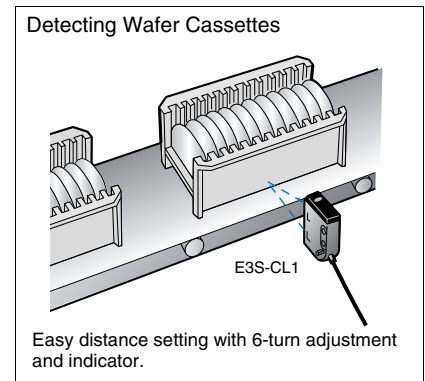
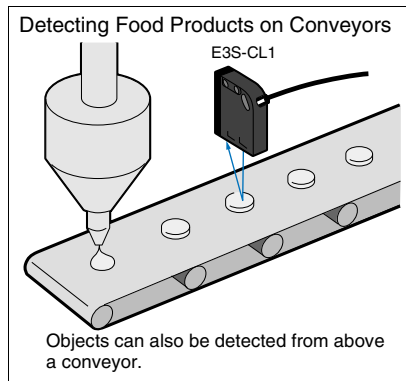
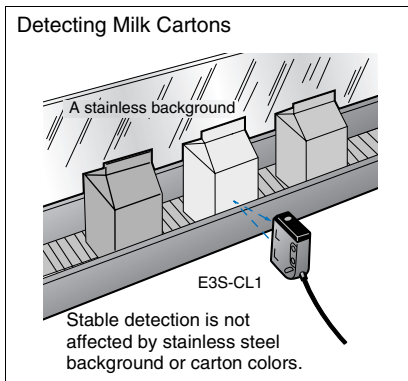

E3S-CL2

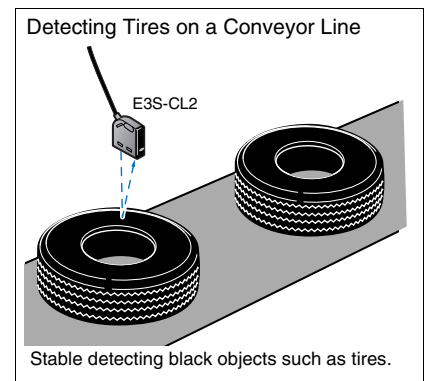
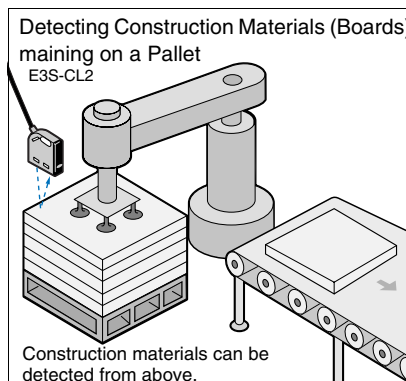
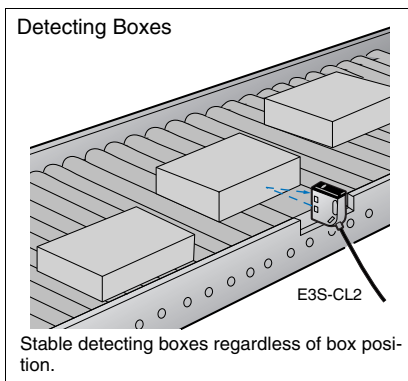

Ordering Information

Red light Infrared light

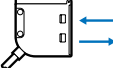
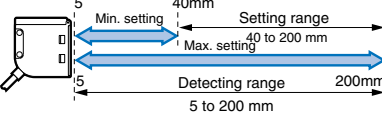
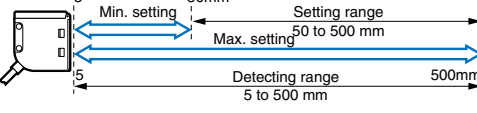
Shape	Sensing/Setting range	Model
		E3S-CL1
		E3S-CL2

Rating/performance

Item	Sensing method	Distance-setting	
	Model	E3S-CL1	E3S-CL2
Sensing		5 to 200 mm (White paper 200 x 200 mm) (Setting distance 200 mm)	5 to 500 mm (White paper 200 x 200 mm) (Setting distance 500 mm)
Setting range		40 to 200 mm (White paper 200 x 200 mm)	50 to 500 mm (White paper 200 x 200 mm)
Differential distance		2% max.	10% max.
Reflectivity characteristics (black/white error)	*1	2% max.	10% max.
Light source (wave length)		Red LED (700 nm)	Infrared LED (860 nm)
Power supply voltage		10 to 30 VDC [ripple (p-p) 10% included]	
Current consumption		35 mA max.	50 mA max.
Control output		Load supply voltage 30 VDC max., load current 100 mA max. (residual voltage NPN output: 1.2 V max., PNP output: 2.0 V max.) Open collector output type (NPN/PNP switch selectable) Light-ON/Dark-ON switch selectable	
Protective circuits		Reverse polarity protection, output short-circuit protection, mutual interference prevention	
Response time		Operation or reset: 1 ms max.	Operation or reset: 2 ms max.
Distance setting		6-turn endless adjuster (with indicator)	
Ambient illuminance		Incandescent lamp: 5,000 lux max. Sunlight 10,000 lux max.	
Ambient temperature		Operating/Storage: -25°C to 55°C (with no icing or condensation)	
Ambient humidity		Operating/Storage: 35% to 85%RH (with no condensation)	
Insulation resistance		20 M min. at 500 VDC	
Dielectric strength		1,000 VAC at 50/60 Hz for 1 minute	
Vibration resistance		10 to 55 Hz, 1.5 mm double amplitude for 2 hours each in X, Y, and Z directions	
Shock resistance		Destruction: 500 m/s ² for 3 times each in X, Y, and Z directions	
Protective structure		IEC Standard IP67, NEMA 6P (limited to indoor use) *2	IEC Standard IP67, NEMA 6P (limited to indoor use)
Connection method		Pre-wired models (standard length: 2 m)	
Weight (Packed state)		Approx. 170 g	
Material	Case	Zinc diecast	
	Operation panel cover	Polyethyl sulfon	
	Lens	Acrylics	
	Mounting Brackets	Stainless steel (SUS304)	
Accessories		Mounting bracket, hexagon bolt M4 x 12 (with spring washer, flat washer), adjusting screwdriver, instruction manual	

*1. Sensing distance difference between standard white paper (reflectivity 90%) and standard black paper (reflectivity 5%)

*2. NEMA (National Electrical Manufacturers Association) Standards

Characteristic data (typical)

Spot Diameter vs. Sensing Distance

E3S-CL1

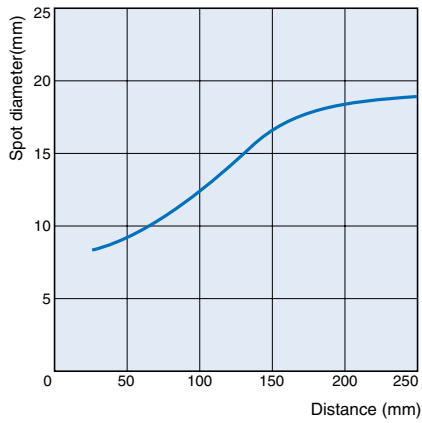

E3S-CL2

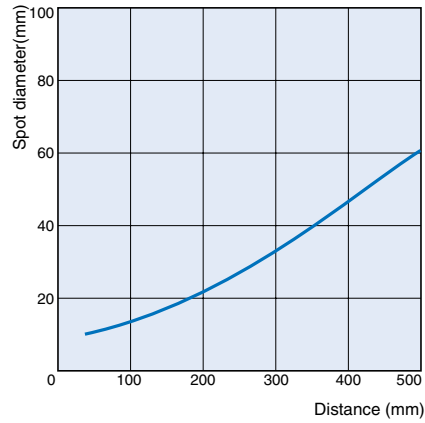

Short distance characteristic

E3S-CL1

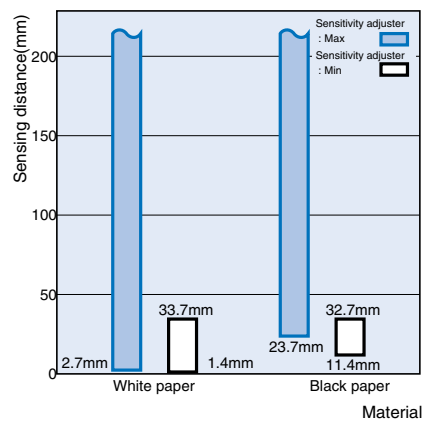

E3S-CL2

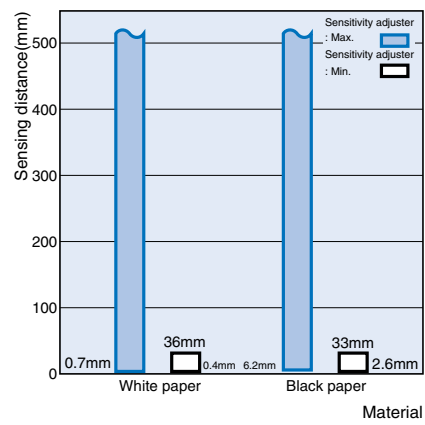

Output Circuit Diagram

NPN output

Model	Operating status of output transistor	Timing chart	Mode selection switch	Output circuit
E3S-CL1 E3S-CL2	Light ON	Incident Interrupted Operation indicator (orange) ON OFF Output transistor ON OFF Load Operate (Relay) Reset	L ON (LIGHT ON)	<p>* Please make a changeover switch into the NPN side.</p>
	Dark ON	Incident Interrupted Operation indicator (orange) ON OFF Output transistor ON OFF Load Operate (Relay) Reset	D ON (DARK ON)	

PNP output

Model	Operating status of output transistor	Timing chart	Mode selection switch	Output circuit
E3S-CL1 E3S-CL2	Light ON	Incident Interrupted Operation indicator (orange) ON OFF Output transistor ON OFF Load Operate (Relay) Reset	L ON (LIGHT ON)	<p>* Please make a changeover switch into the PNP side.</p>
	Dark ON	Incident Interrupted Operation indicator (orange) ON OFF Output transistor ON OFF Load Operate (Relay) Reset	D ON (DARK ON)	

Nomenclature:

Operation panel

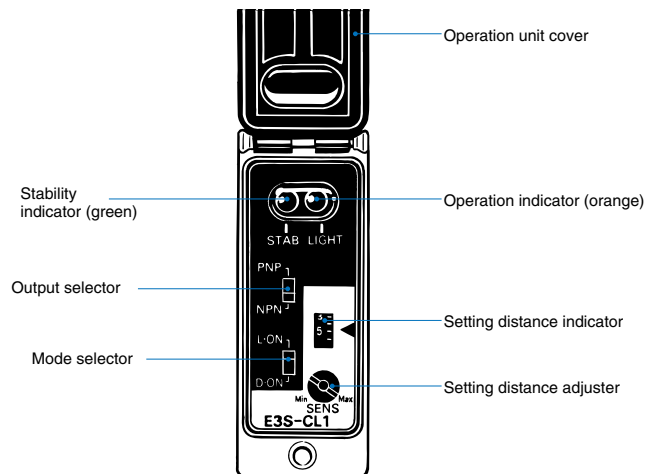

Output selection switch

- ① When using the sensor with NPN output, move the switch to the **NPN** position.
- ② When using the sensor with PNP output, move the switch to the **PNP** position.

Mode selection switch

- ① When using the sensor with Light-ON, move the switch to the **L•ON** position.
- ② When using the sensor with Dark-ON, move the switch to the **D•ON** position.

Distance Adjuster

- ① Turning the distance setting adjuster clockwise (to the Max position) increases the detecting ZD distance, and turning it counterclockwise (to the Min position) decreases the distance.
- ② The distance setting adjuster is a 6-turn endless adjuster ranging from the Min position to the Max position, and its number of turns is displayed on the setting distance indicator according to the rotation of the adjuster.

Operation

Sensitivity adjustment (distance setting type, Light-ON)

Sequence	Detection state	Position of distance setting adjuster	State of setting distance indicator	Indicator state	Adjustment Steps
(1) Point (A)				ON→OFF OFF→ON Stability indicator (green) Operation indicator (orange)	Place a sensing object in the predetermined position, turn the adjuster clockwise until the incident indicator (orange) is turned ON, and define this position as (A).
(2) Points (B), (C)				ON→OFF ON→OFF Stability indicator (green) Operation indicator (orange)	(1) If there is a background object, remove the sensing object, turn the adjuster further clockwise until the incident indicator (orange) is turned ON, and define this position as (B). Turn the adjuster counterclockwise from (B) until the incident indicator (orange) is turned OFF, and define this position as (C). (2) If there is no background object, define the maximum adjuster position (Max) as (C).
(3) Setting	---			ON ON↔OFF Stability indicator (green) Operation indicator (orange)	Set the adjuster in the middle of positions (A) and (C). Also make sure that the stability indicator (green) is turned ON when there is an object and when there is no object. When the indicator is not turned ON, reexamine the detection method since there is a little allowance.

Precautions

Correct Use

Design

Cable

The oil-resistant cable is used to ensure oil resistance. (E3S-CL2)

Installation

Sensor installation

Mounting orientation

- Install the photoelectric sensor in such manner that its detection surface and the object surface are parallel (without inclination relative to the sensing object).

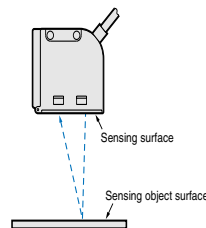

If the sensing object has a glossy surface, incline the Sensor by 5° to 10° as shown on the right. In this case, ensure that the Sensor is not influenced by any background objects.

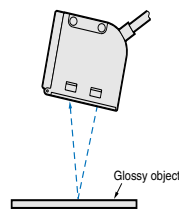

- If there is a mirror-smooth object under the photoelectric sensor, operation may become instable. Therefore, incline the photoelectric sensor as shown below or move it away from the object.

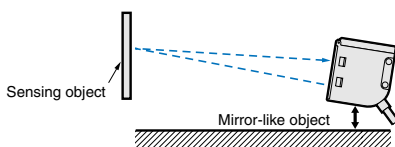

- Install the photoelectric sensor in either of the following orientations, being careful of the direction in which the sensing object will move.

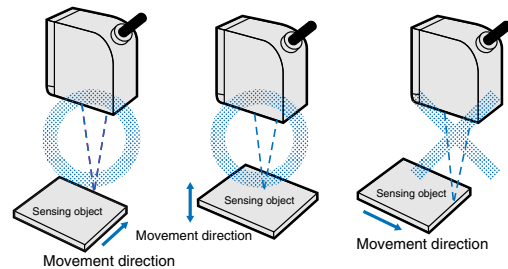

- Also, when the color/material of the sensing object varies extremely, install the photoelectric sensor in either of the following orientations.

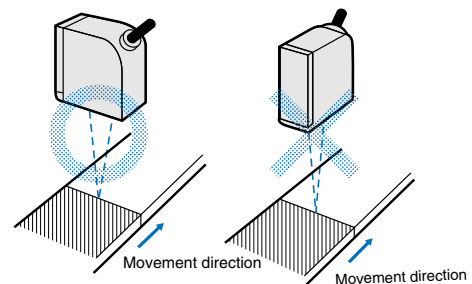

- Install the photoelectric sensor so that the sun, fluorescent lamp, incandescent lamp or any other strong light will not enter the directional angle range of the sensor.

Mounting Precautions

- Do not strike the Photoelectric Sensor with a hammer or any other tool during the installation of the Sensor, or the Sensor will lose its water-resistant properties.
- Use M4 screws.
- Tighten the screws to the torque of 1.2 Nm max.

Others

Oil resistance/chemical resistance (E3S-CL2)

For the oil resistance of E3S-CL2, the Sensor has passed tests on the oils given in the following table. Refer to the table for examining the oil to be used. Depending on the oil type, however, the Sensor may not be able to exhibit its performance.

Testing oil classification	JIS classification	Product name	Dynamic viscosity (mm ² /s) at 40°C	PH
Lubricant	---	Velocity No. 3	2.02	---
Water-insoluble coolant	Class 2 No. 5	Daphne Cut	Not less than 10 to less than 50	
	Class 2 No. 11	Yushiron Oil No. 2ac	Less than 10	
Water-soluble coolant	Class W1 No. 1	Yushiroken EC50T-3	---	7'9.5
		Yushiron Lubic HWC68		7'9.9
	Class W1 No. 2	Gryton 1700D		7'9.2
	Class W2 No. 1	Yushiroken S50N		7'9.8

Note: 1. E3S-C was submerged in the oils in the above table at 50°C for 240 hours, and passed the test of 100-M or more insulation resistance.
 2. For use in the environment where E3S-C is exposed to the oil other than those in the above table, use the dynamic viscosity and PH in the above table. Pre-check the oils since the sensor may be affected by additives etc. in the oils.

Dimensions (Unit: mm)

E3S-CL1
E3S-CL2

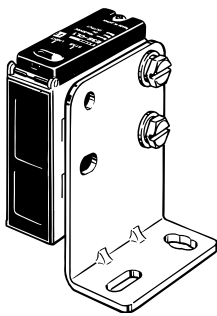

With Mounting Bracket Attached

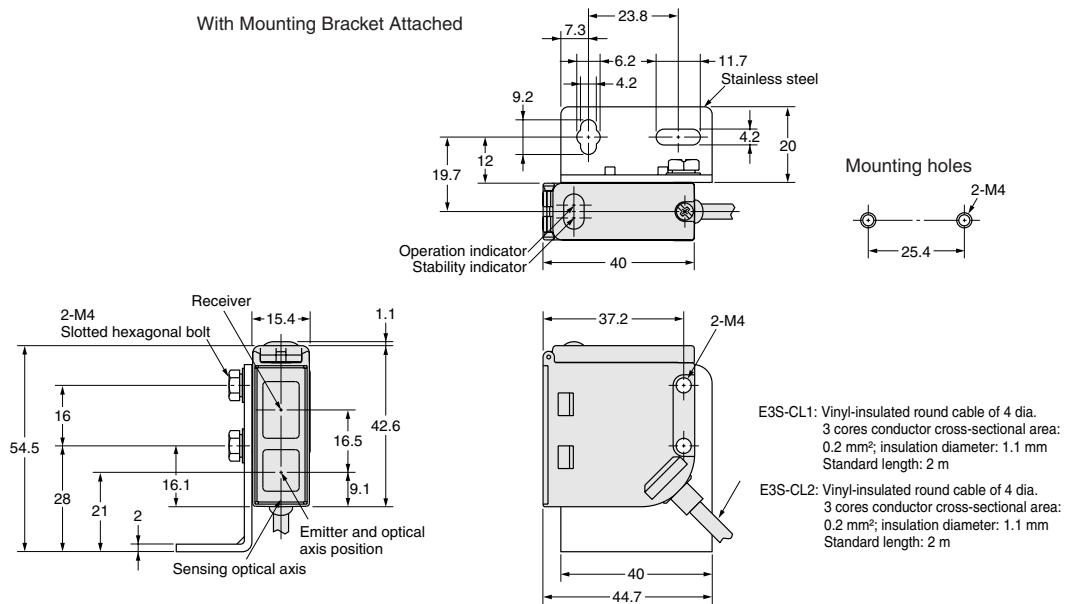

Note: The output selector, mode selector and distance setting adjuster are exposed when the cover is opened.

По вопросам продаж и поддержки обращайтесь:

- | | | | |
|-----------------------------|---------------------------------|--------------------------------|---------------------------|
| Архангельск (8182)63-90-72 | Казань (843)206-01-48 | Новокузнецк (3843)20-46-81 | Смоленск (4812)29-41-54 |
| Астана +7(7172)727-132 | Калининград (4012)72-03-81 | Новосибирск (383)227-86-73 | Сочи (862)225-72-31 |
| Астрахань (8512)99-46-04 | Калуга (4842)92-23-67 | Омск (3812)21-46-40 | Ставрополь (8652)20-65-13 |
| Барнаул (3852)73-04-60 | Кемерово (3842)65-04-62 | Орел (4862)44-53-42 | Сургут (3462)77-98-35 |
| Белгород (4722)40-23-64 | Киров (8332)68-02-04 | Оренбург (3532)37-68-04 | Тверь (4822)63-31-35 |
| Брянск (4832)59-03-52 | Краснодар (861)203-40-90 | Пенза (8412)22-31-16 | Томск (3822)98-41-53 |
| Владивосток (423)249-28-31 | Красноярск (391)204-63-61 | Пермь (342)205-81-47 | Тула (4872)74-02-29 |
| Волгоград (844)278-03-48 | Курск (4712)77-13-04 | Ростов-на-Дону (863)308-18-15 | Тумень (3452)66-21-18 |
| Вологда (8172)26-41-59 | Липецк (4742)52-20-81 | Рязань (4912)46-61-64 | Ульяновск (8422)24-23-59 |
| Воронеж (473)204-51-73 | Магнитогорск (3519)55-03-13 | Самара (846)206-03-16 | Уфа (347)229-48-12 |
| Екатеринбург (343)384-55-89 | Москва (495)268-04-70 | Санкт-Петербург (812)309-46-40 | Хабаровск (4212)92-98-04 |
| Иваново (4932)77-34-06 | Мурманск (8152)59-64-93 | Саратов (845)249-38-78 | Челябинск (351)202-03-61 |
| Ижевск (3412)26-03-58 | Набережные Челны (8552)20-53-41 | Севастополь (8692)22-31-93 | Череповец (8202)49-02-64 |
| Иркутск (395) 279-98-46 | Нижний Новгород (831)429-08-12 | Симферополь (3652)67-13-56 | Ярославль (4852)69-52-93 |

Киргизия (996)312-96-26-47

Казахстан (772)734-952-31

Таджикистан (992)427-82-92-69