

# Built-in Power Supply Photoelectric Sensor

## E3JK <NEW>

### Long-distance Photoelectric Sensor That Supports AC/DC Power Supplies



- Long sensing distance that is approximately 8 times that of our conventional model (for the Through-beam and Diffuse-reflective models). (Through-beam: 40 m, Retro-reflective: 7 m, and Diffuse-reflective: 2.5 m.)
- Improved visibility:
  - A red LED that makes the spot visible.
  - Large indicators that can be seen even from a distance.
- Improved operability. (Enlarged sensitivity adjuster and operation selector)
- Freely selectable power supply input (24 to 240 VDC, 24 to 240 VAC). (Additional types added to the DC type lineup.)
- Models with infrared LEDs are also available.



For the most recent information on models that have been certified for safety standards, refer to your OMRON website.



Refer to the *Safety Precautions* on page 15.

### Applications

Elevator cage detection



Detection of packages jutting out from their storage location

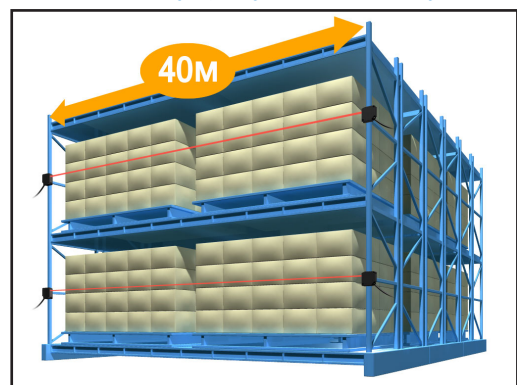

Pallet detection for agricultural produce conveyors

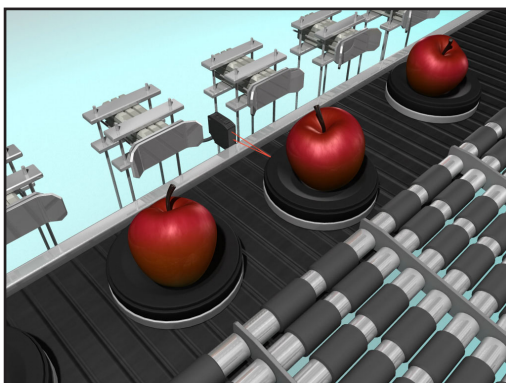

Workpiece detection for woodworking machines

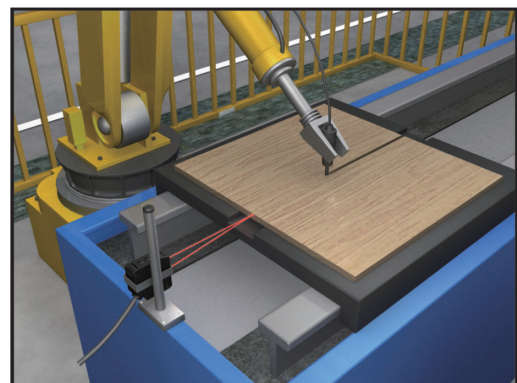











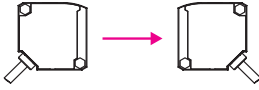

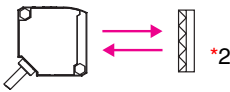

# E3JK

## Ordering Information

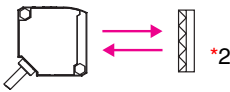
### Sensors

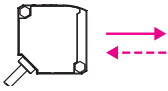
#### Sensors without Brackets or Reflectors

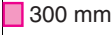
 Red light  Infrared light

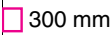















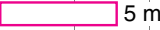

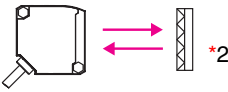

Power supply voltage	Sensing method	Appearance	Sensing distance	Output configuration	Model	
AC/DC power supply selectable type	Through-beam *1 (Emitter + Receiver)		 40 m	Relay	<b>E3JK-TR11 2M</b> Emitter: E3JK-TR11-L 2M Receiver: E3JK-TR11-D 2M	
			 5 m		<b>E3JK-TR12 2M</b> Emitter: E3JK-TR12-L 2M Receiver: E3JK-TR12-D 2M	
			 40 m		<b>E3JK-TR13 2M</b> Emitter: E3JK-TR13-L 2M Receiver: E3JK-TR13-D 2M	
			 5 m		<b>E3JK-TR14 2M</b> Emitter: E3JK-TR14-L 2M Receiver: E3JK-TR14-D 2M	
	Retro-reflective without MSR function		 7 m [100 mm] (*3) (When using E39-R1)		<b>E3JK-RR11 2M</b>	
			 11 m [100 mm] (When using E39-R2)			
			 7 m [100 mm] (*3) (When using E39-R1)			
			 11 m [100 mm] (When using E39-R2)			
	Retro-reflective with MSR function		 6 m [100 mm] (*3) (When using E39-R1)			<b>E3JK-RR12 2M</b>
			 10 m [100 mm] (When using E39-R2)			
	Diffuse-reflective		 2.5 m			<b>E3JK-DR11 2M</b>
			 300 mm			
			 2.5 m		<b>E3JK-DR12 2M</b>	
			 300 mm			

\*1. Through-beam Sensors are sold in sets that include both the Emitter and Receiver.

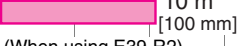
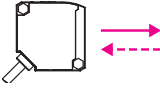
\*2. A Reflector is not included. Purchase a Reflector separately to match the intended use of the Sensor.

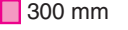
\*3. Values in parentheses indicate the minimum required distances between the Sensors and Reflectors.

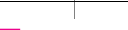
 Red light  Infrared light

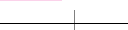
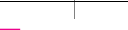
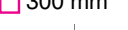









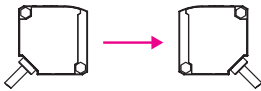

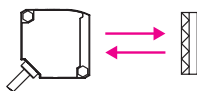

Power supply voltage	Sensing method	Appearance	Sensing distance	Output configuration	Model		
DC	Through-beam *1 (Emitter + Receiver)		 40 m	NPN	<b>E3JK-TN11 2M</b> Emitter: E3JK-TN11-L 2M Receiver: E3JK-TN11-D 2M		
			 40 m	PNP	<b>E3JK-TP11 2M</b> Emitter: E3JK-TP11-L 2M Receiver: E3JK-TP11-D 2M		
			 5 m	NPN	<b>E3JK-TN12 2M</b> Emitter: E3JK-TN12-L 2M Receiver: E3JK-TN12-D 2M		
			 5 m	PNP	<b>E3JK-TP12 2M</b> Emitter: E3JK-TP12-L 2M Receiver: E3JK-TP12-D 2M		
			 40 m	NPN	<b>E3JK-TN13 2M</b> Emitter: E3JK-TN13-L 2M Receiver: E3JK-TN13-D 2M		
			 40 m	PNP	<b>E3JK-TP13 2M</b> Emitter: E3JK-TP13-L 2M Receiver: E3JK-TP13-D 2M		
			 5 m	NPN	<b>E3JK-TN14 2M</b> Emitter: E3JK-TN14-L 2M Receiver: E3JK-TN14-D 2M		
			 5 m	PNP	<b>E3JK-TP14 2M</b> Emitter: E3JK-TP14-L 2M Receiver: E3JK-TP14-D 2M		
			Retro-reflective without MSR function		 7 m [100 mm] (*3) (When using E39-R1)	NPN	<b>E3JK-RN11 2M</b>
					 11 m [100 mm] (When using E39-R2)	PNP	<b>E3JK-RP11 2M</b>
					 7 m [100 mm] (*3) (When using E39-R1)	NPN	<b>E3JK-RN13 2M</b>
					 11 m [100 mm] (When using E39-R2)	PNP	<b>E3JK-RP13 2M</b>
	Retro-reflective with MSR function	 6 m [100 mm] (*3) (When using E39-R1)			NPN	<b>E3JK-RN12 2M</b>	
		 10 m [100 mm] (When using E39-R2)			PNP	<b>E3JK-RP12 2M</b>	
	Diffuse-reflective		 2.5 m	NPN	<b>E3JK-DN11 2M</b>		
			 300 mm	PNP	<b>E3JK-DP11 2M</b>		
			 2.5 m	NPN	<b>E3JK-DN12 2M</b>		
			 300 mm	PNP	<b>E3JK-DP12 2M</b>		
			 2.5 m	NPN	<b>E3JK-DN13 2M</b>		
			 300 mm	PNP	<b>E3JK-DP13 2M</b>		
				 2.5 m	NPN	<b>E3JK-DN14 2M</b>	
			 300 mm	PNP	<b>E3JK-DP14 2M</b>		

\*1. Through-beam Sensors are sold in sets that include both the Emitter and Receiver.  
 \*2. A Reflector is not included. Purchase a Reflector separately to match the intended use of the Sensor.  
 \*3. Values in parentheses indicate the minimum required distances between the Sensors and Reflectors.

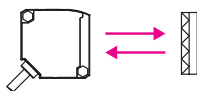
## Sensors

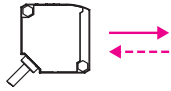
 Red light  Infrared light

### Sensors with Brackets and Reflectors (The model numbers contain ("C."))

Power supply voltage	Sensing method	Appearance	Sensing distance	Output configuration	Model		
AC/DC power supply selectable type	Through-beam *1 (Emitter + Receiver)		 40m	Relay	<b>E3JK-TR11-C 2M</b> Emitter: E3JK-TR11-L 2M Receiver: E3JK-TR11-D 2M		
			 5m		<b>E3JK-TR12-C 2M</b> Emitter: E3JK-TR12-L 2M Receiver: E3JK-TR12-D 2M		
			 40 m		<b>E3JK-TR13-C 2M</b> Emitter: E3JK-TR13-L 2M Receiver: E3JK-TR13-D 2M		
			 5 m		<b>E3JK-TR14-C 2M</b> Emitter: E3JK-TR14-L 2M Receiver: E3JK-TR14-D 2M		
	Retro-reflective without MSR function		 7m *2 [100mm] (When using E39-R1)		Relay	<b>E3JK-RR11-C 2M</b>	
			 11m [100mm] (When using E39-R2)				
			 7 m *2 [100 mm] (When using E39-R1)				
			 11 m [100 mm] (When using E39-R2)				
	Retro-reflective with MSR function		 6m *2 [100mm] (When using E39-R1)		Relay	<b>E3JK-RR12-C 2M</b>	
			 10m [100mm] (When using E39-R2)				
	Diffuse-reflective		 2.5m		Relay	<b>E3JK-DR11-C 2M</b>	
			 300mm				<b>E3JK-DR12-C 2M</b>
			 2.5 m				
			 300 mm				<b>E3JK-DR14-C 2M</b>

\*1. Through-beam Sensors are sold in sets that include both the Emitter and Receiver.

\*2. Values in parentheses indicate the minimum required distances between the Sensors and Reflectors.

**Accessories (Order Separately)**

**Reflectors** (A Reflector is required for each Retro-reflective Sensor.) [Refer to *Dimensions* on page 17.]

The E39-R1 is enclosed with Sensors with model numbers that contain “-C.”

Name	Sensing distance (rated value)		Model	Quantity
Reflectors	E3JK-R□11	7 m [100 mm] *	E39-R1	1
	E3JK-R□12	6 m [100 mm] *		
	E3JK-R□13	7 m [100 mm] *		
	E3JK-R□11	9 m [100 mm] *	E39-R1S	1
	E3JK-R□12	7 m [100 mm] *		
	E3JK-R□13	9 m [100 mm] *		
	E3JK-R□11	11 m [100 mm] *	E39-R2	1
	E3JK-R□12	10 m [100 mm] *		
	E3JK-R□13	11 m [100 mm] *		

**Note:** Refer to *Engineering Data* on page 12 for details.

\*Values in parentheses indicate the minimum required distances between the Sensors and Reflectors.

**Mounting Bracket** [Refer to *Dimensions* on page 17.]

A Mounting Bracket is enclosed with Sensors with model numbers that contain “-C.”

Appearance	Model	Quantity
	E39-L40	1

**Note:** 1. When using a Through-beam Sensor, order one Mounting Bracket for the Receiver and one for the Emitter.

2. For details, refer to *Mounting Brackets* on E39-L/E39-S/E39-R which can be accessed from your OMRON website.

# E3JK

## Ratings and Specifications

Sensing method		Through-beam			
Item	Model	E3JK-TR11-□	E3JK-TR12-□	E3JK-TR13-□	E3JK-TR14-□
Sensing distance		40 m	5 m	40 m	5 m
Standard sensing object		Opaque: 17-mm dia. min.			
Differential travel		-			
Directional angle		Both Emitter and Receiver 3° min.			
Light source (wavelength)		Red LED (624 nm)		Infrared LED (850 nm)	
Power supply voltage		24 to 240 VDC ±10%, ripple (p-p): 10% max. 24 to 240 VAC ±10%, 50/60 Hz			
Power consumption	DC	3 W max. (Emitter 1.5 W max. Receiver 1.5 W max.)			
	AC	3 W max. (Emitter 1.5 W max. Receiver 1.5 W max.)			
Control output		Relay output SPDT, 250 VAC, 3 A max. (cosφ= 1), 5 VDC, 10 mA min., Light-ON/Dark-ON selectable			
Protection circuits		-			
Life expectancy (relay output)	Mechanical	50,000,000 times min. (switching frequency: 18,000 times/h)			
	Electrical	100,000 times min. (switching frequency: 1,800 times/h)			
Response time		20 ms max.			
Sensitivity adjustment		One-turn adjuster Receiver (E3JK-TR1□-D) only			
Ambient illumination (Receiver side)		Incandescent lamp: 3,000 lx max., Sunlight: 11,000 lx max.			
Ambient temperature range		Operating: -25°C to 55°C, Storage: -40°C to 70°C (with no icing or condensation)			
Ambient humidity range		Operating: 35% to 85%, Storage: 35% to 95% (with no condensation)			
Insulation resistance		20 MΩ min. at 500 VDC			
Dielectric strength		1,500 VAC, 50/60 Hz for 1 min			
Vibration resistance	Destruction	10 to 55 Hz with a 1.5 mm double amplitude for 2 hours each in X, Y, and Z directions			
	Malfunction	10 to 55 Hz with a 1.5 mm double amplitude for 2 hours each in X, Y, and Z directions			
Shock resistance	Destruction	500 m/s <sup>2</sup> for 3 times each in X, Y, and Z directions			
	Malfunction	100 m/s <sup>2</sup> for 3 times each in X, Y, and Z directions			
Degree of protection		IEC 60529 IP64			
Connection method		Pre-wired (standard length: 2 m)			
Weight (packed state)		Approx. 350 g			
Material	Case	ABS (Acrylonitrile Butadiene Styrene)			
	Lens/Display window	Methacrylic resin			
	Adjuster	POM			
	Cable	PVC			
Bending radius of cable		R18			
Accessories		Instruction manual and Mounting Bracket (E3JK-TR1□-C only)			

Sensing method		Retro-reflective (without MSR function)		Retro-reflective (with MSR function)
Item	Model	E3JK-RR11-□	E3JK-RR13-□	E3JK-RR12-□
<b>Sensing distance</b>		7 m [100 mm]* (When using E39-R1), 11 m [100 mm]* (When using E39-R2)		6 m [100 mm]* (When using E39-R1), 10 m [100 mm]* (When using E39-R2)
<b>Standard sensing object</b>		Opaque: 75-mm dia. min.		
<b>Differential travel</b>		-		
<b>Directional angle</b>		1.5° min.		
<b>Light source (wavelength)</b>		Red LED (624 nm)	Infrared LED (850 nm)	Red LED (624 nm)
<b>Power supply voltage</b>		24 to 240 VDC ±10%, ripple (p-p): 10% max. 24 to 240 VAC ±10%, 50/60 Hz		
<b>Power consumption</b>	<b>DC</b>	2 W max.		
	<b>AC</b>	2 W max.		
<b>Control output</b>		Relay output SPDT, 250 VAC, 3 A max. (cosφ= 1), 5 VDC, 10 mA min., Light-ON/Dark-ON selectable		
<b>Protection circuits</b>		Mutual interference prevention function		
<b>Life expectancy (relay output)</b>	<b>Mechanical</b>	50,000,000 times min. (switching frequency: 18,000 times/h)		
	<b>Electrical</b>	100,000 times min. (switching frequency: 1,800 times/h)		
<b>Response time</b>		20 ms max.		
<b>Sensitivity adjustment</b>		One-turn adjuster		
<b>Ambient illumination (Receiver side)</b>		Incandescent lamp: 3,000 lx max., Sunlight: 11,000 lx max.		
<b>Ambient temperature range</b>		Operating: -25°C to 55°C, Storage: -40°C to 70°C (with no icing or condensation)		
<b>Ambient humidity range</b>		Operating: 35% to 85%, Storage: 35% to 95% (with no condensation)		
<b>Insulation resistance</b>		20 MΩ min. at 500 VDC		
<b>Dielectric strength</b>		1,500 VAC, 50/60 Hz for 1 min		
<b>Vibration resistance</b>	<b>Destruction</b>	10 to 55 Hz with a 1.5 mm double amplitude for 2 hours each in X, Y, and Z directions		
	<b>Malfunction</b>	10 to 55 Hz with a 1.5 mm double amplitude for 2 hours each in X, Y, and Z directions		
<b>Shock resistance</b>	<b>Destruction</b>	500 m/s <sup>2</sup> for 3 times each in X, Y, and Z directions		
	<b>Malfunction</b>	100 m/s <sup>2</sup> for 3 times each in X, Y, and Z directions		
<b>Degree of protection</b>		IEC 60529 IP64		
<b>Connection method</b>		Pre-wired (standard length: 2 m)		
<b>Weight (packed state)</b>		Approx. 180 g		
<b>Material</b>	<b>Case</b>	ABS (Acrylonitrile Butadiene Styrene)		
	<b>Lens/Display window</b>	Methacrylic resin		
	<b>Adjuster</b>	POM		
	<b>Cable</b>	PVC		
<b>Bending radius of cable</b>		R18		
<b>Accessories</b>		Instruction manual, Mounting Bracket (E3JK-RR1□-C only), and Reflector (E3JK-RR1□-C only)		

\*Values in parentheses indicate the minimum required distances between the Sensors and Reflectors.

Sensing method		Diffuse-reflective			
Item	Model	E3JK-DR11-□	E3JK-DR12-□	E3JK-DR13-□	E3JK-DR14-□
Sensing distance		White paper (300 × 300 mm): 2.5 m	White paper (100 × 100 mm): 300 mm	White paper (300 × 300 mm): 2.5 m	White paper (100 × 100 mm): 300 mm
Standard sensing object		-			
Differential travel		20% max. of sensing distance			
Directional angle		-			
Light source (wavelength)		Red LED (624 nm)		Infrared LED (850 nm)	
Power supply voltage		24 to 240 VDC ±10%, ripple (p-p): 10% max. 24 to 240 VAC ±10%, 50/60 Hz			
Power consumption	DC	2 W max.			
	AC	2 W max.			
Control output		Relay output SPDT, 250 VAC, 3 A max. (cosφ= 1), 5 VDC, 10 mA min., Light-ON/Dark-ON selectable			
Protection circuits		Mutual interference prevention function			
Life expectancy (relay output)	Mechanical	50,000,000 times min. (switching frequency: 18,000 times/h)			
	Electrical	100,000 times min. (switching frequency: 1,800 times/h)			
Response time		20 ms max.			
Sensitivity adjustment		One-turn adjuster			
Ambient illumination (Receiver side)		Incandescent lamp: 3,000 lx max., Sunlight: 11,000 lx max.			
Ambient temperature range		Operating: -25°C to 55°C, Storage: -40°C to 70°C (with no icing or condensation)			
Ambient humidity range		Operating: 35% to 85%, Storage: 35% to 95% (with no condensation)			
Insulation resistance		20 MΩ min. at 500 VDC			
Dielectric strength		1,500 VAC, 50/60 Hz for 1 min			
Vibration resistance	Destruction	10 to 55 Hz with a 1.5 mm double amplitude for 2 hours each in X, Y, and Z directions			
	Malfunction	10 to 55 Hz with a 1.5 mm double amplitude for 2 hours each in X, Y, and Z directions			
Shock resistance	Destruction	500 m/s <sup>2</sup> for 3 times each in X, Y, and Z directions			
	Malfunction	100 m/s <sup>2</sup> for 3 times each in X, Y, and Z directions			
Degree of protection		IEC 60529 IP64			
Connection method		Pre-wired (standard length: 2 m)			
Weight (packed state)		Approx. 180 g			
Material	Case	ABS (Acrylonitrile Butadiene Styrene)			
	Lens/Display window	Methacrylic resin			
	Adjuster	POM			
	Cable	PVC			
Bending radius of cable		R18			
Accessories		Instruction manual and Mounting Bracket (E3JK-DR1□-C only)			



Item	Sensing method		Through-beam			
	Model	NPN output	E3JK-TN11	E3JK-TN12	E3JK-TN13	E3JK-TN14
		PNP output	E3JK-TP11	E3JK-TP12	E3JK-TP13	E3JK-TP14
Sensing distance			40 m	5 m	40 m	5 m
Standard sensing object			Opaque: 17-mm dia. min.			
Differential travel			-			
Directional angle			Both Emitter and Receiver 3° min.			
Light source (wavelength)			Red LED (624 nm)		Infrared LED (850 nm)	
Power supply voltage			10 to 30 VDC, including ripple (p-p): 10%			
Power consumption	DC		40 mA max. (Emitter 25 mA max. Receiver 15 mA max.)			
	AC		-			
Control output			Load power supply voltage: 30 V max., Load current: 100 mA max., Residual voltage: 3 V max., open-collector output (NPN/PNP output depending on model), Light-ON/Dark-ON selectable			
Protection circuits			Power supply reverse polarity protection, Output short-circuit protection, and Output reverse polarity protection			
Life expectancy (relay output)	Mechanical		-			
	Electrical		-			
Response time			1 ms max.			
Sensitivity adjustment			One-turn adjuster Receiver (E3JK-T□□□-D) only			
Ambient illumination (Receiver side)			Incandescent lamp: 3,000 lx max., Sunlight: 11,000 lx max.			
Ambient temperature range			Operating: -25°C to 55°C, Storage: -40°C to 70°C (with no icing or condensation)			
Ambient humidity range			Operating: 35% to 85%, Storage: 35% to 95% (with no condensation)			
Insulation resistance			20 MΩ min. at 500 VDC			
Dielectric strength			1,500 VAC, 50/60 Hz for 1 min			
Vibration resistance	Destruction		10 to 55 Hz with a 1.5 mm double amplitude for 2 hours each in X, Y, and Z directions			
	Malfunction		10 to 55 Hz with a 1.5 mm double amplitude for 2 hours each in X, Y, and Z directions			
Shock resistance	Destruction		500 m/s <sup>2</sup> for 3 times each in X, Y, and Z directions			
	Malfunction		500 m/s <sup>2</sup> for 3 times each in X, Y, and Z directions			
Degree of protection			IEC 60529 IP64			
Connection method			Pre-wired (standard length: 2 m)			
Weight (packed state)			Approx. 300 g			
Material	Case		ABS (Acrylonitrile Butadiene Styrene)			
	Lens/Display window		Methacrylic resin			
	Adjuster		POM			
	Cable		PVC			
Bending radius of cable			R18			
Accessories			Instruction manual			

# E3JK

		Sensing method		Retro-reflective (without MSR function)		Retro-reflective (with MSR function)	
Item	Model	NPN output	E3JK-RN11	E3JK-RN13	E3JK-RN12		
		PNP output	E3JK-RP11	E3JK-RP13	E3JK-RP12		
<b>Sensing distance</b>		7 m [100 mm]* (When using E39-R1), 11 m [100 mm]* (When using E39-R2)			6 m [100 mm]* (When using E39-R1), 10 m [100 mm]* (When using E39-R2)		
<b>Standard sensing object</b>		Opaque: 75-mm dia. min.					
<b>Differential travel</b>		-					
<b>Directional angle</b>		1.5° min.					
<b>Light source (wavelength)</b>		Red LED (624 nm)		Infrared LED (850 nm)		Red LED (624 nm)	
<b>Power supply voltage</b>		10 to 30 VDC, including ripple (p-p): 10%					
<b>Power consumption</b>	DC	30 mA max.					
	AC	-					
<b>Control output</b>		Load power supply voltage: 30 V max., Load current: 100 mA max., Residual voltage: 3 V max., open-collector output (NPN/PNP output depending on model), Light-ON/Dark-ON selectable					
<b>Protection circuits</b>		Power supply reverse polarity protection, Output short-circuit protection, Mutual interference prevention function, and Output reverse polarity protection					
<b>Life expectancy (relay output)</b>	Mechanical	-					
	Electrical	-					
<b>Response time</b>		1 ms max.					
<b>Sensitivity adjustment</b>		One-turn adjuster					
<b>Ambient illumination (Receiver side)</b>		Incandescent lamp: 3,000 lx max., Sunlight: 11,000 lx max.					
<b>Ambient temperature range</b>		Operating: -25°C to 55°C, Storage: -40°C to 70°C (with no icing or condensation)					
<b>Ambient humidity range</b>		Operating: 35% to 85%, Storage: 35% to 95% (with no condensation)					
<b>Insulation resistance</b>		20 MΩ min. at 500 VDC					
<b>Dielectric strength</b>		1,500 VAC, 50/60 Hz for 1 min					
<b>Vibration resistance</b>	Destruction	10 to 55 Hz with a 1.5 mm double amplitude for 2 hours each in X, Y, and Z directions					
	Malfunction	10 to 55 Hz with a 1.5 mm double amplitude for 2 hours each in X, Y, and Z directions					
<b>Shock resistance</b>	Destruction	500 m/s <sup>2</sup> for 3 times each in X, Y, and Z directions					
	Malfunction	500 m/s <sup>2</sup> for 3 times each in X, Y, and Z directions					
<b>Degree of protection</b>		IEC 60529 IP64					
<b>Connection method</b>		Pre-wired (standard length: 2 m)					
<b>Weight (packed state)</b>		Approx. 160 g					
<b>Material</b>	Case	ABS (Acrylonitrile Butadiene Styrene)					
	Lens/Display window	Methacrylic resin					
	Adjuster	POM					
	Cable	PVC					
<b>Bending radius of cable</b>		R18					
<b>Accessories</b>		Instruction manual					

\*Values in parentheses indicate the minimum required distances between the Sensors and Reflectors.

Model		Sensing method	Diffuse-reflective			
			NPN output	E3JK-DN11	E3JK-DN12	E3JK-DN13
Item	PNP output		E3JK-DP11	E3JK-DP12	E3JK-DP13	E3JK-DP14
Sensing distance			White paper (300 × 300 mm): 2.5 m	White paper (100 × 100 mm): 300 mm	White paper (300 × 300 mm): 2.5 m	White paper (100 × 100 mm): 300 mm
Standard sensing object			-			
Differential travel			20% max. of sensing distance			
Directional angle			-			
Light source (wavelength)			Red LED (624 nm)		Infrared LED (850 nm)	
Power supply voltage			10 to 30 VDC, including ripple (p-p): 10%			
Power consumption		DC	30 mA max.			
		AC	-			
Control output			Load power supply voltage: 30 V max., Load current: 100 mA max., Residual voltage: 3 V max., open-collector output (NPN/PNP output depending on model), Light-ON/Dark-ON selectable			
Protection circuits			Power supply reverse polarity protection, Output short-circuit protection, Mutual interference prevention function, and Output reverse polarity protection			
Life expectancy (relay output)		Mechanical	-			
		Electrical	-			
Response time			1 ms max.			
Sensitivity adjustment			One-turn adjuster			
Ambient illumination (Receiver side)			Incandescent lamp: 3,000 lx max., Sunlight: 11,000 lx max.			
Ambient temperature range			Operating: -25°C to 55°C, Storage: -40°C to 70°C (with no icing or condensation)			
Ambient humidity range			Operating: 35% to 85%, Storage: 35% to 95% (with no condensation)			
Insulation resistance			20 MΩ min. at 500 VDC			
Dielectric strength			1,500 VAC, 50/60 Hz for 1 min			
Vibration resistance		Destruction	10 to 55 Hz with a 1.5 mm double amplitude for 2 hours each in X, Y, and Z directions			
		Malfunction	10 to 55 Hz with a 1.5 mm double amplitude for 2 hours each in X, Y, and Z directions			
Shock resistance		Destruction	500 m/s <sup>2</sup> for 3 times each in X, Y, and Z directions			
		Malfunction	500 m/s <sup>2</sup> for 3 times each in X, Y, and Z directions			
Degree of protection			IEC 60529 IP64			
Connection method			Pre-wired (standard length: 2 m)			
Weight (packed state)			Approx. 160 g			
Material		Case	ABS (Acrylonitrile Butadiene Styrene)			
		Lens/Display window	Methacrylic resin			
		Adjuster	POM			
		Cable	PVC			
Bending radius of cable			R18			
Accessories			Instruction manual			

# E3JK

## Engineering Data (Reference Value)

### Parallel Operating Range

#### Through-beam

##### E3JK-T□11/T□13

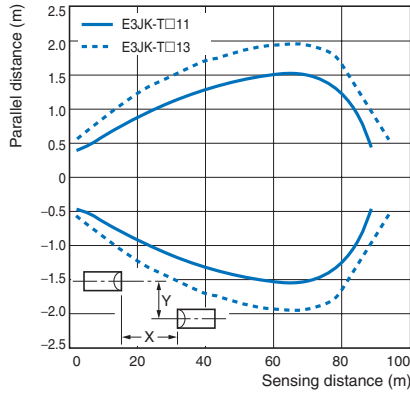

##### E3JK-T□12/T□14

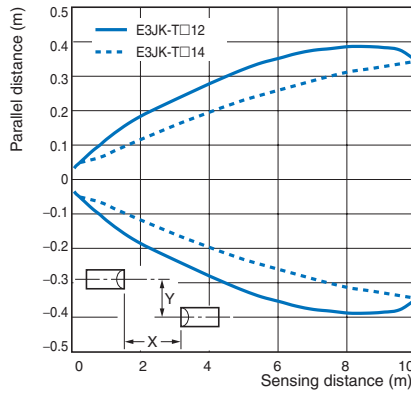

#### Retro-reflective

##### E3JK-R□□1+E39-R1/

##### E3JK-R□□3+E39-R1

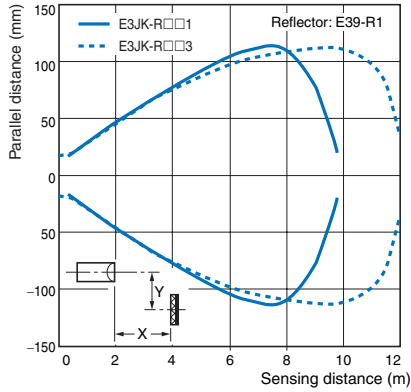

##### E3JK-R□□1+E39-R1S/

##### E3JK-R□□3+E39-R1S

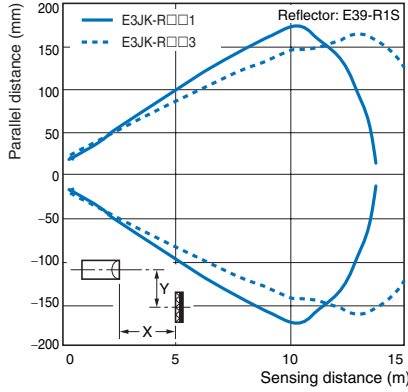

##### E3JK-R□□1+E39-R2/

##### E3JK-R□□3+E39-R2

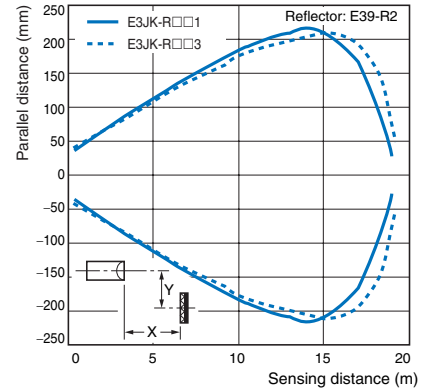

##### E3JK-R□□2+E39-R1

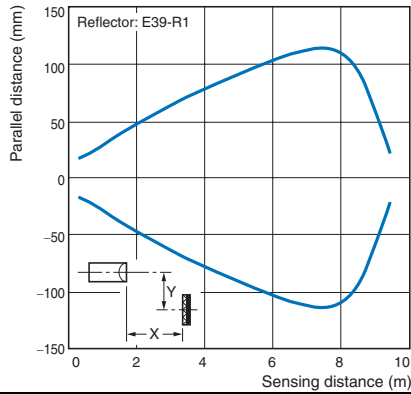

##### E3JK-R□□2+E39-R1S

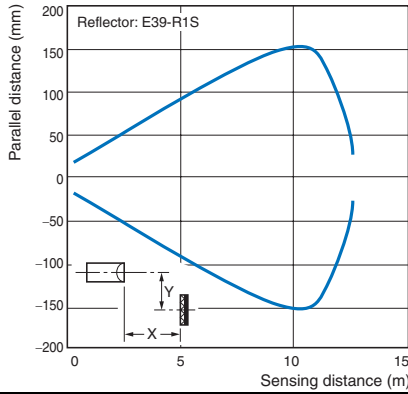

##### E3JK-R□□2+E39-R2

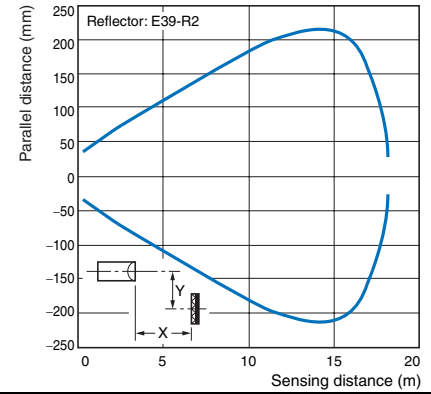

### Operating Range

#### Diffuse-reflective

##### E3JK-D□□1/D□□3

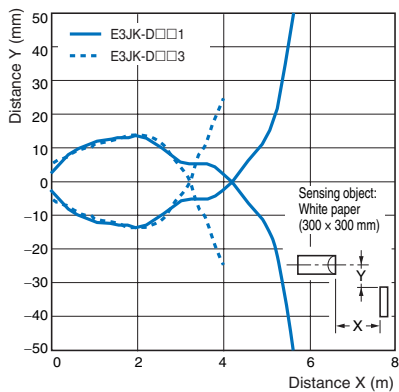

##### E3JK-D□□2/D□□4

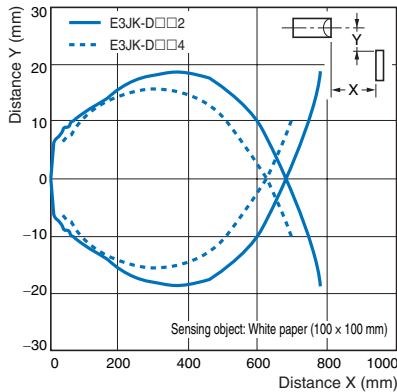

## Excess Gain Ratio vs. Set Distance

### Through-beam

#### E3JK-T□11/T□13

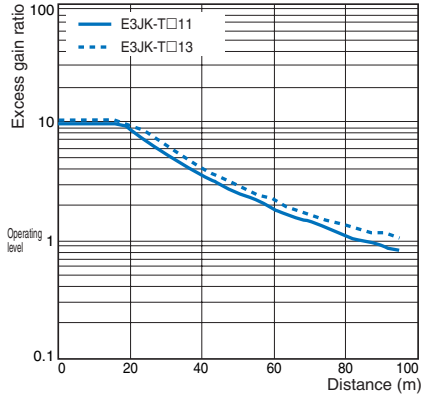

#### E3JK-T□12/T□14

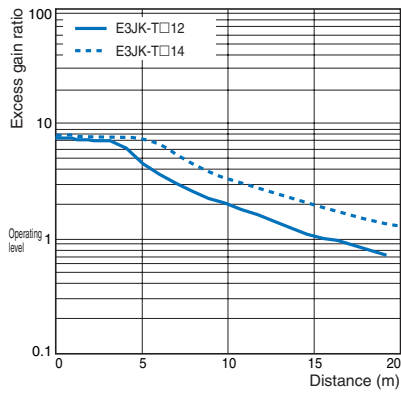

### Retro-reflective

#### E3JK-R□□1+E39-R1/ E3JK-R□□3+E39-R1

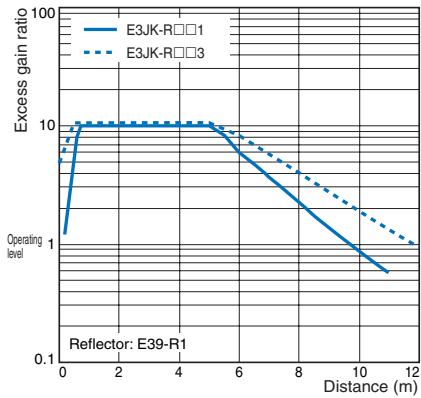

#### E3JK-R□□1+E39-R1S/ E3JK-R□□3+E39-R1S

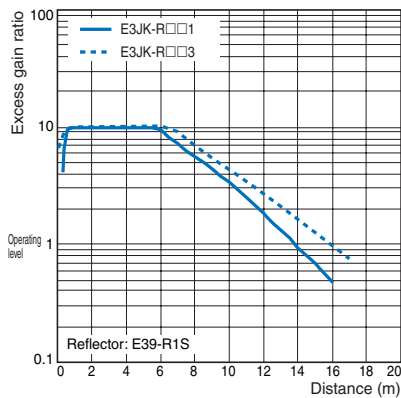

#### E3JK-R□□1+E39-R2/ E3JK-R□□3+E39-R2

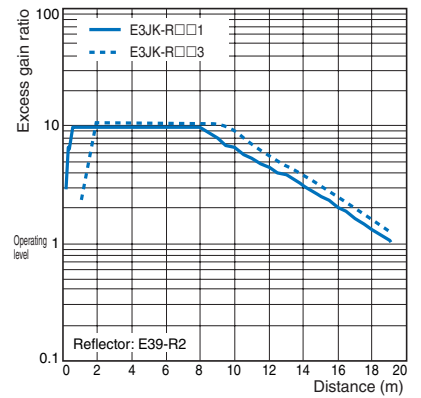

#### E3JK-R□□2+E39-R1

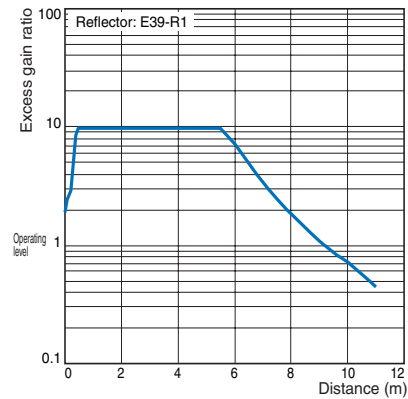

#### E3JK-R□□2+E39-R1S

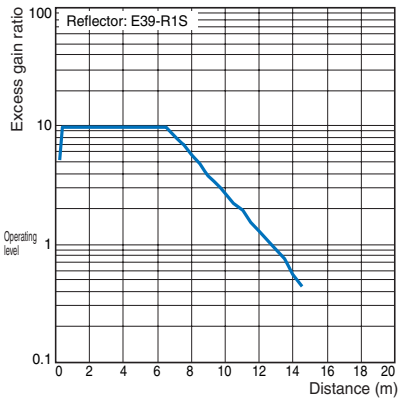

#### E3JK-R□□2+E39-R2

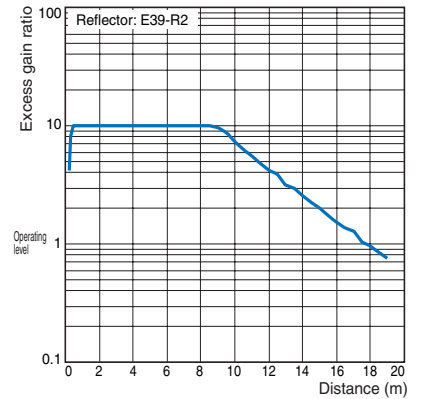

### Diffuse-reflective

#### E3JK-D□□1/D□□3

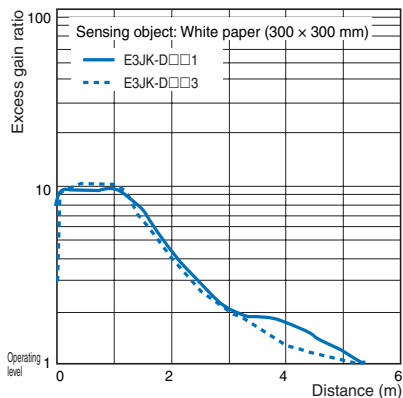

#### E3JK-D□□2/D□□4

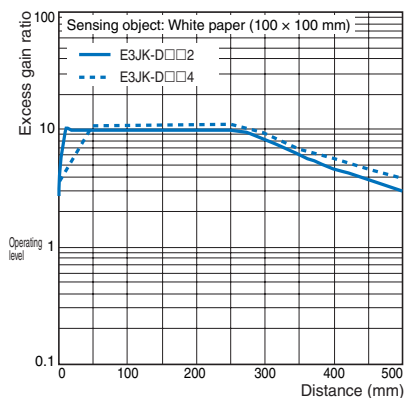

# E3JK

## I/O Circuit Diagrams

### Relay Output Models

Model	Timing chart		Output circuit
	Light-ON	Dark-ON	
E3JK-TR11-L * E3JK-TR12-L * E3JK-TR13-L * E3JK-TR14-L *	/		
E3JK-TR11-D * E3JK-TR12-D * E3JK-TR13-D * E3JK-TR14-D * E3JK-RR11 E3JK-RR12 E3JK-RR13 E3JK-DR11 E3JK-DR12 E3JK-DR13 E3JK-DR14			

### DC SSR Output Models

Model	Timing chart		Output circuit
	Light-ON	Dark-ON	
E3JK-TN11-L * E3JK-TP11-L * E3JK-TN12-L * E3JK-TP12-L * E3JK-TN13-L * E3JK-TP13-L * E3JK-TN14-L * E3JK-TP14-L *	/		
E3JK-TN11-D * E3JK-TN12-D * E3JK-TN13-D * E3JK-TN14-D * E3JK-RN11 E3JK-RN12 E3JK-RN13 E3JK-DN11 E3JK-DN12 E3JK-DN13 E3JK-DN14			
E3JK-TP11-D * E3JK-TP12-D * E3JK-TP13-D * E3JK-TP14-D * E3JK-RP11 E3JK-RP12 E3JK-RP13 E3JK-DP11 E3JK-DP12 E3JK-DP13 E3JK-DP14			

**Note:** Connect the brown cable to any polarity and the blue cable to the power supply because there is no polarity on the Emitter side.

\*For the Through-beam Sensor, the Emitter is listed as E3JK-T□11-L, E3JK-T□12-L and the Receiver is listed as E3JK-T□11-D, E3JK-T□12-D in the table. Confirm the models to order in "Ordering Information."

## Safety Precautions

Refer to *Warranty and Limitations of Liability*.

### WARNING

This product is not designed or rated for ensuring safety of persons either directly or indirectly.



Do not use it for such purposes.

### Caution

Do not wire the product incorrectly.  
Do not use this product with a damaged case or cable.



Do not disassemble, repair, or modify this product.  
Doing so may lead to explosion, fire, or product failure.



### Precautions for Safe Use

The following precautions must be observed to ensure safe operation of the Sensor.

1. Do not use the Sensor in environments subject to flammable, explosive or corrosive gases.
2. Do not use this product in an environment in which oil or chemicals are present.
3. Do not use this product under water, in the rain, or outdoors.
4. Do not use this product under conditions that exceed or in an environment that exceeds the ratings.
5. When using an AC power supply, do not use a power supply that includes high frequencies (such as an inverter).
6. Do not use this product in a location subject to direct sunlight.
7. Do not use this product in a location in which the product will be subject to direct vibrations or impacts.
8. Do not use thinner, alcohol, or other organic solvents with this product.
9. When disposing of the Sensor, treat it as industrial waste.

### Precautions for Correct Use

- If the product is wired to high-voltage power lines and power lines in the same pipe or the same duct, the product may malfunction or be damaged due to induction. Therefore, in principle, perform these two types of wiring separately or use shielded cords.
- Do not apply excessive force to the cables.
- When using a commercially available switching regulator, be sure to install an FG (frame ground terminal).
- The time between the product being turned ON and sensing being possible is 100 ms, so wait at least 100 ms after turning the product ON before using it. If the load and the product are connected to different power supplies, be sure to turn the product ON first.
- An output pulse may be generated when the product is turned OFF, so we recommend turning the load or the load line OFF first.

# E3JK

## Dimensions

(Unit: mm)

Tolerance class IT16 applies to dimensions in this datasheet unless otherwise specified.

### Sensors

#### Through-beam E3JK-T□1□

#### <Emitter> E3JK-T□1□-L

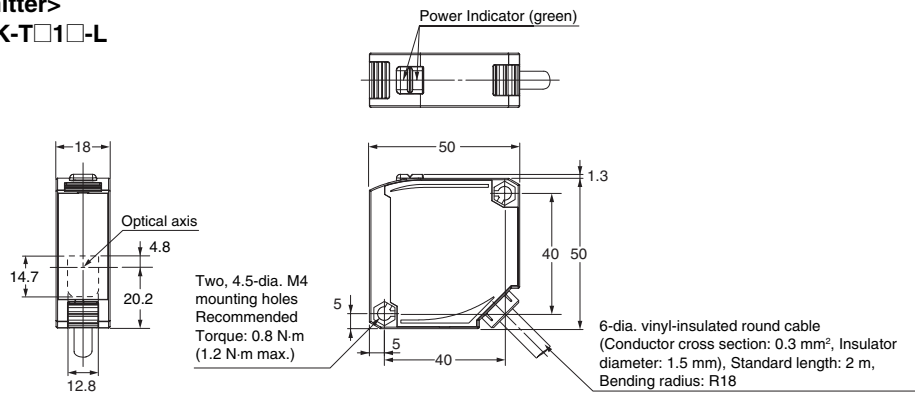

#### <Receiver> E3JK-T□1□-D

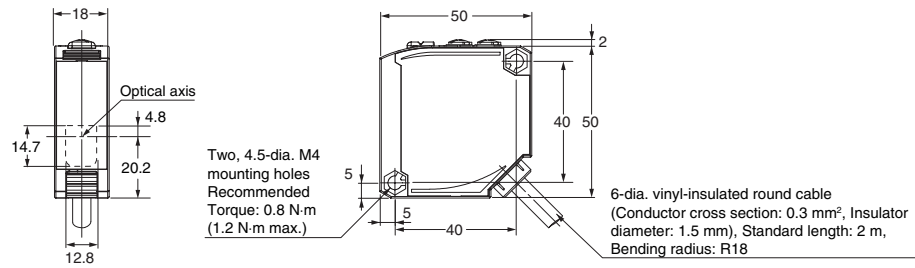
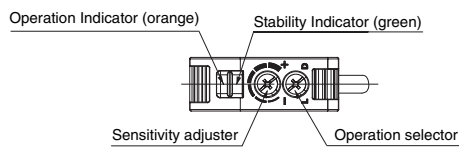

#### Retro-reflective/ Diffuse-reflective

#### E3JK-R□1□ E3JK-D□1□

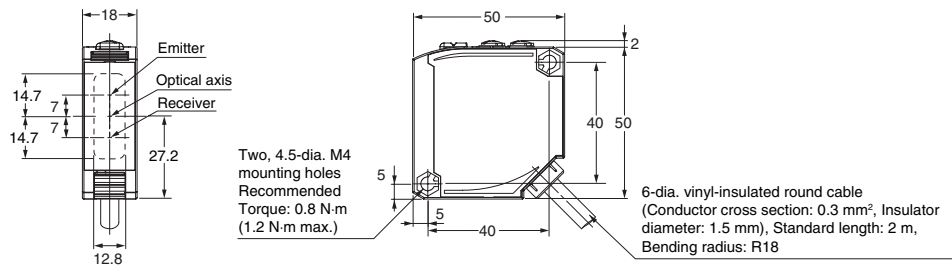
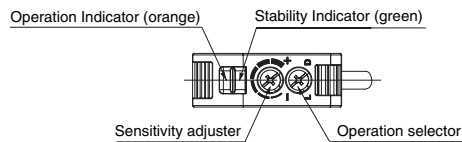



Accessories

Mounting Bracket (Order separately)

Mounting Bracket  
E39-L40

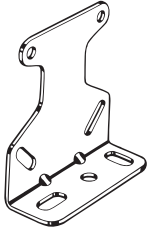

Material: Iron

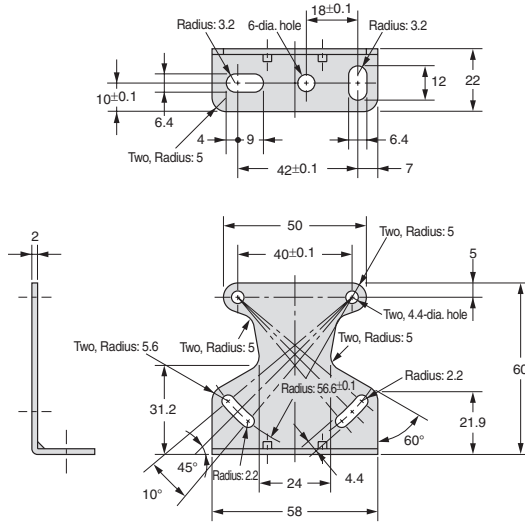

With Mounting Bracket Attached

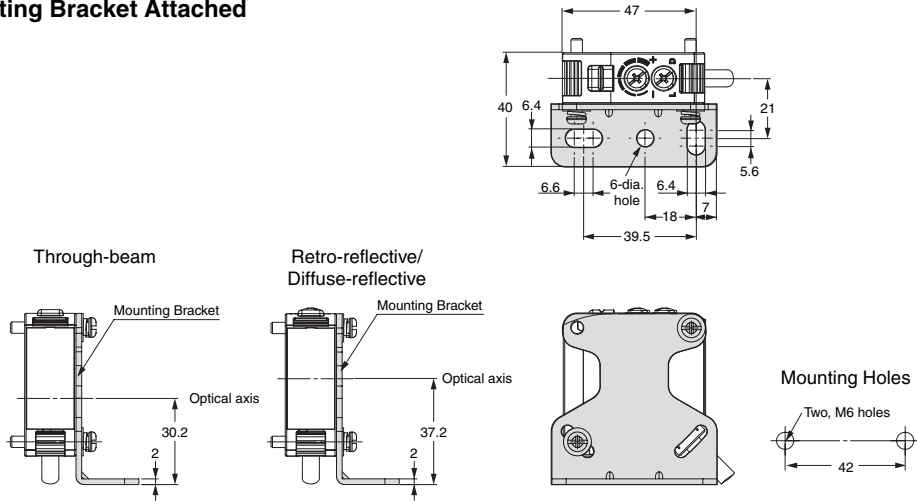

Reflector (Order separately)

E39-R1  
E39-R1S



Material:  
Reflective surface: acrylic  
Rear surface: ABS

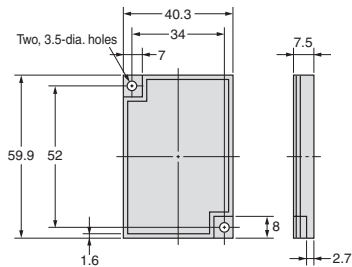

E39-R2

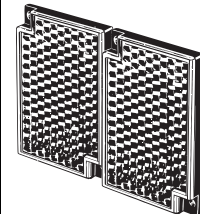

Material:  
Reflective surface: acrylic  
Rear surface: ABS

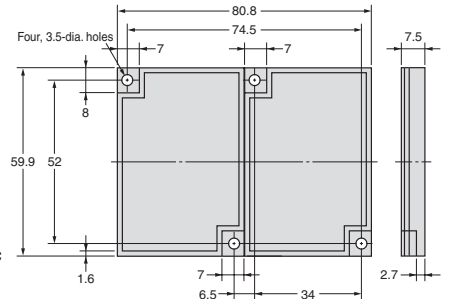

**По вопросам продаж и поддержки обращайтесь:**

Архангельск (8182)63-90-72	Казань (843)206-01-48	Новокузнецк (3843)20-46-81	Смоленск (4812)29-41-54
Астана +7(7172)727-132	Калининград (4012)72-03-81	Новосибирск (383)227-86-73	Сочи (862)225-72-31
Астрахань (8512)99-46-04	Калуга (4842)92-23-67	Омск (3812)21-46-40	Ставрополь (8652)20-65-13
Барнаул (3852)73-04-60	Кемерово (3842)65-04-62	Орел (4862)44-53-42	Сургут (3462)77-98-35
Белгород (4722)40-23-64	Киров (8332)68-02-04	Оренбург (3532)37-68-04	Тверь (4822)63-31-35
Брянск (4832)59-03-52	Краснодар (861)203-40-90	Пенза (8412)22-31-16	Томск (3822)98-41-53
Владивосток (423)249-28-31	Красноярск (391)204-63-61	Пермь (342)205-81-47	Тула (4872)74-02-29
Волгоград (844)278-03-48	Курск (4712)77-13-04	Ростов-на-Дону (863)308-18-15	Тюмень (3452)66-21-18
Вологда (8172)26-41-59	Липецк (4742)52-20-81	Рязань (4912)46-61-64	Ульяновск (8422)24-23-59
Воронеж (473)204-51-73	Магнитогорск (3519)55-03-13	Самара (846)206-03-16	Уфа (347)229-48-12
Екатеринбург (343)384-55-89	Москва (495)268-04-70	Санкт-Петербург (812)309-46-40	Хабаровск (4212)92-98-04
Иваново (4932)77-34-06	Мурманск (8152)59-64-93	Саратов (845)249-38-78	Челябинск (351)202-03-61
Ижевск (3412)26-03-58	Набережные Челны (8552)20-53-41	Севастополь (8692)22-31-93	Череповец (8202)49-02-64
Иркутск (395) 279-98-46	Нижний Новгород (831)429-08-12	Симферополь (3652)67-13-56	Ярославль (4852)69-52-93

Киргизия (996)312-96-26-47      Казахстан (772)734-952-31      Таджикистан (992)427-82-92-69

Эл. почта: [orm@nt-rt.ru](mailto:orm@nt-rt.ru) || Сайт: <http://omron.nt-rt.ru>